

The Sanford Herald

Tuesday, October 3, 1972—Sanford, Florida 32771
65th Year, No. 3 Price 10 Cents

Light Voting Predicted Today In State's Runoff Primaries

By JERE MOORE JR., TALLAHASSEE, Fla. (AP) — Some hotly contested local races were expected to bring out moderate crowds of voters in a few areas of the state today, but the turnout in most places for the runoff elections was expected to be light. Secretary of State Richard Stone predicted less than 20 percent of the 3 million voters would go to the polls, fewer than the about 600,000 who voted in the first primary Sept. 12.

He had predicted 2 million would vote then. "This is as pessimistic as the first prediction was optimistic," Stone said, "I hope I am just as wrong." Some sharp name calling has been exchanged in the race for the 5th District Republican congressional nomination, one of three congressional runoffs on today's ballot, all involving districts created by this year's reapportionment. Charles Rainey, 40, of Clear-

water, and Jack Insko, 43, of Port Richey, also have been fighting over who has the backing of President Nixon. State GOP Chairman L. E. "Tommy" Thomas issued a statement Monday to say the Florida Committee for the Re-election of the President is neutral in Republican primaries and to specifically disclaim a mailer indicating the committee supported Rainey. Rainey and former Gov. Claude Kirk visited an Insko

rally in New Port Richey Saturday and Kirk said afterward he backed Rainey. In the 13th District Democratic race, State Sen. Lee Weissenborn, 43, has admitted knowledge before the Sept. 12 primary that his aides were preparing a counteroffer endorsement list. This has given impetus to the campaign of William Lehman, 58, a former school board chairman.

Lake County Improvement SR 46 Bids Opened

By FRED VAN PELT

State Department of Transportation is about to commence improvement of the balance of State Road 46 West, linking Mt. Dora and Sanford, it was revealed today by Douglas Stenstrom, chairman of the Greater Sanford Chamber of Commerce long range planning committee.

SR 46 links with the principal north-south traffic artery, U.S. 441, immediately east of Mt. Dora.

C. A. (Bill) Benedict, DeLand, district engineer for DOT, reported to Stenstrom that DOT has opened bids for widening and resurfacing SR 46 between the Seminole-Lake County line, the Wekiva River, and Mt. Dora, a distance of about 15 miles. The DOT just recently completed constructing a new highway for SR 46 between Interstate 4 and the Wekiva River, in Seminole County, a distance of 10 miles.

Benedict reported Leecon, of Leesburg, was apparent low bidder for the Lake County project with \$949,073. The work will consist of widening the present pavement from 18 feet to 24 feet, and the construction of eight-foot shoulders. The entire project will be resurfaced.

Awarding of the contract for the work is expected within 10 days or two weeks. Actual construction is expected to require about a year.

DOT is making a survey for Lake County in order that Lake County might acquire right-of-way for future expansion of SR 46.

Stenstrom also reported that contract has been awarded to four-lane SR 436 West to the Seminole-Orange County line, near Apopka. Contract was awarded to Ewell Engineering and Contracting Company, of Lakeland, on its bid of \$2,334,686 and allows for 360

working days. When this work is completed all of SR 436 in Seminole County will be four-laned.

Benedict also reported that the Osteen Bridge design report has been approved by DOT and the Federal Highway Administration. This means that all matters relating to the location, the design of the project and its effect on the environment have been completed.

Next step will be the actual drafting of the plans for the construction of the bridge and the road, estimated to cost about \$2 million. The drafting will require eight-10 months, with the project scheduled for awarding of the contract in the 1973-74 fiscal year.

Survey has been completed and right-of-way map is being prepared by DOT for improvement of SR 419, between Oviedo and Five Points.



PERHAPS THOSE SAME HIGH WINDS

Will also carry the voters of Seminole County to the polls today, and disprove earlier predictions of an anticipated poor voter turnout. These signs, located at the "triangle" of Highway 17-92 and Seminole Boulevard in Sanford, were first reported to have been damaged by vandals. Further inspection revealed it was caused by high winds, and not vandalism. If today's voter response is poor, what will have caused it?

On Armed Guards Schools Cautious

By BILL SCOTT

Seminole County School Board in a three-two vote Monday night made mandatory a motion by A. P. Bue Jr. that School Supt. John Angel must receive board permission before two security guards hired to patrol Seminole High School may carry arms.

The action has the effect of amending a previous board action which specified the patrol could wear items sufficient for their protection.

Because this was too vague and all encompassing, Bue advised he would seek to have the issue spelled out in more concise terms, even though Angel had assured the board that his intention was to have security personnel keep order using sticks and Mace.

Voting in support of Bue were Dr. Stuart Culpepper and A. F. Keeth. Opposing the motion and voting "nay" were Jean Bryant and Ray Slaton. By its action, the board takes the opposite view than that held by Sanford Police Chief Ben Butler and Sheriff John Polk.

Both lawmen in a meeting at the outset of trouble at the school told the board they would not allow their men still on temporary duty at the 13-12 grade facility, to remain unless they carry guns.

Sheriff Polk explained, "a 14-year-old can kill just as much as a 40-year-old," in advising of his feelings about guards carrying guns.

The men, when hired must receive 200 hours of police training before they will be deputized for duty and assigned to the school to prevent further violence that caused two students to be hospitalized during the first week of the new term for injuries received in a melee involving fighting high schoolers.

In another board action, an 18-year-old youth was expelled and becomes the first expulsion from Seminole High School this year after it was reported to the board the youth was guilty of

using profanity toward the principal and was insubordinate. A group of Eastbrook and Lake Howell parents were on hand again at attempt to coerce the board into using its entire funds to establish a portable middle school on Tusawilla Road.

Dr. Culpepper proposed that Lawson Elementary School at Oviedo be rescheduled as a middle school and the present Jackson Heights Middle School be rescheduled as an elementary school.

Later, Culpepper proposed using plans for the present Teague Middle School as a model for a new Eastbrook Middle School permanent plant. Culpepper also brought up the need for enlarging Jackson Heights Middle School to handle

the overflow expected there from Oviedo when the eighth grade is required to be located elsewhere since the space is needed for the high school 9-12 grades.

After much discussion of Culpepper's proposals, the board agreed informally that if the November referendum giving more funds to the schools is approved by the voters then the first priority is a new permanent middle school in the Eastbrook area.

Bulletin
WASHINGTON (AP)—A proposed full-scale congressional investigation of the break-in at Democratic headquarters in the Watergate Hotel was rejected today by the House Banking Committee.

TOYOTA TOYOTA TOYOTA	
USED CAR	
CLEARANCE SALE	
60 Buick Special	\$100
64 Chevrolet Convertible	\$450
65 Pontiac Tempest	\$300
65 Oldsmobile Convertible	\$450
64 Olds Vista Cruiser Wgn.	\$200
63 English Ford	\$300
64 Ford Ranchero	\$250
68 VW	\$700
68 Olds Delta 88, DeLia	\$795
64 Buick Special	\$300

LOW BANK FINANCING
ECONOMY CARS OF SANFORD, INC.
OPEN EVENINGS

SPECIAL FOR FOLKS 65 AND OVER

Union Fidelity Life is licensed by the State of FLORIDA

ACT NOW! THE EXPIRATION DATE OF MIDNIGHT Oct. 11, 1972 WILL NOT BE EXTENDED. Get your Application and \$1 in the mail today to our Licensed Resident Agent: John R. Sharron, Box 1609, Panama City, Fla. 32401

GIVE THIS EXTRA APPLICATION FORM TO A FRIEND, NEIGHBOR OR RELATIVE.

919 OFFICIAL APPLICATION FORM TO UNION FIDELITY LIFE INSURANCE COMPANY PHILADELPHIA, PENNSYLVANIA 47131

1919

MR. MRS. MISS First Middle Initial Last (If you are a married woman - use your own first name)

ADDRESS Street or R.D. No. STATE ZIP

CITY STATE ZIP

DATE OF BIRTH Month Day Year AGE SEX Male Female

OCCUPATION BENEFICIARY

I also apply for my spouse Spouse's first name and middle initial Month Day Year

I have enclosed my first monthly premium and hereby apply to Union Fidelity Life Insurance Company, Philadelphia, Pa. 19102 for Elder Care Plan, Form 919. I understand that my policy will become effective when issued, that no hospital room benefits are payable for the first 60 days of any benefit period, no benefits are payable for doctors' bills as a result of surgery or medical treatment, and the initial Medicare deductible is not covered.

SIGNATURE X DATE

Counter-signed By: Licensed Resident Agent (Sign - Do Not Print) Oct. 11, 1972 62 UFA 7117 2 FLA (CS)

THIS IS YOUR COUPON FILL IT IN AND MAIL TODAY.

919 OFFICIAL APPLICATION FORM TO UNION FIDELITY LIFE INSURANCE COMPANY PHILADELPHIA, PENNSYLVANIA 47131

1919

MR. MRS. MISS First Middle Initial Last (If you are a married woman - use your own first name)

ADDRESS Street or R.D. No. STATE ZIP

CITY STATE ZIP

DATE OF BIRTH Month Day Year AGE SEX Male Female

OCCUPATION BENEFICIARY

I also apply for my spouse Spouse's first name and middle initial Month Day Year

I have enclosed my first monthly premium and hereby apply to Union Fidelity Life Insurance Company, Philadelphia, Pa. 19102 for Elder Care Plan, Form 919. I understand that my policy will become effective when issued, that no hospital room benefits are payable for the first 60 days of any benefit period, no benefits are payable for doctors' bills as a result of surgery or medical treatment, and the initial Medicare deductible is not covered.

SIGNATURE X DATE

Counter-signed By: Licensed Resident Agent (Sign - Do Not Print) Oct. 11, 1972 62 UFA 7117 2 FLA (CS)



By John A. Spolski

Let's all hear it for the Internal Revenue Service, folks. Commissioner Johnnie Walters of the Atlanta office says "shocking scheme by giant corporations have been discovered."

The agency is recommending criminal prosecution and tax penalties... with as much dispatch I'm sure as the Watergate fiasco?

Be glad you're not living in Chipley, Florida. In their local election, Theron Cook, a candidate for sheriff, is being sought for allegedly cashing a bad check in Alabama last year.

Earlier two of the three doctors on the county's hospital staff had resigned and fled town, claiming their lives were threatened...

Was wondering when it would arrive... and today was "the day". Rodney Parker of 2012 Cedar Avenue of Sanford sent his letter to Santa Claus. (I don't blame you, Rodney... knowing how long it sometimes takes for a letter to get to us from nearby Orlando... well, you're just not taking a chance on it being late, right?)

Look... before some of the very busy intersections of Sanford Avenue and 27th Street, and at Airport Boulevard and Park Avenue... can't we get someone to apply for these crossing guard jobs?

The pay is minimal - only \$1.60 an hour... but the thought of possibly saving a life should be more than enough compensation, right? Give Principal Heckenbach at Pincecrest Elementary School a call if you're interested... please!

It may be coincidence but have you noticed how many more road crews are at work, now that the elections are upon us?

Most folks don't vote for something... they vote against someone or something.

First Witness Testifies In DeBose Murder Trial

By MARION BETHEA

The trial of Stanley DeBose, charged with the first degree murder of Vera Lee Mathis on Aug. 7, got underway this morning with the state calling its first witness, Joe Burton.

The case is being tried before a six-man jury, an innovation brought about by the abolition of capital punishment.

Assistant State Attorney Newman Brock outlined the state's case in his opening remarks, in which he noted the case is a "murder perpetrated by robbery."

Defense Attorney Ned Julian Jr. reserved his opening statements until later in the trial.

Burton testified he was living with the deceased on Aug. 7, and had been for 18 months

watching television and reading.

She said water entered two rooms but hastily explained these rooms are not being used. As she spoke another attendant used bed sheets to soak up the water that was backing up on the floor.

The home was purchased about a year ago from Sanford Nursing Home, Inc. by First Atlas Corporation of Gloucester, Mass., Mrs. Hollenbeck said. Most of the patients at the facility (90 per cent) are under Medicaid (state welfare), the administrator said. She related further that no Medicare (Social Security funded) patients are at the facility.

Mrs. Hollenbeck refused to allow Herald photographer Bill Vincent Jr. to take pictures of the roof conditions but permitted the entry of a reporter to view the scene.

She further advised that bids had been taken for a new roof and that Montgomery-Ward of Casselberry was given the job and started Monday. However, a representative from the county sanitation office reported he was at the home and did not see workmen but had been told the roof was being repaired. This morning there were no workmen on duty when Herald staffers were on the scene.

prior to that time. In what was to become a series of verbal blasts between Brock and Julian, when Brock queried the witness if he was aware Mrs. Mathis was a widow, Julian objected on the basis it was a leading question and would lead to a "chain of bad habits of leading questions."

Burton went on to relate Mrs. Mathis' home was adjacent to the store which she operated and in which she was allegedly hacked to death.

On the day of Mrs. Mathis' demise, Burton testified, she had planned a "country dinner" for some relatives, and he went in search of collard greens for the repast, leaving her in the store.

Burton said he was caught in a "hard rain" which delayed

his return and that later he attempted to get into the store. The door was hooked on the inside. He then rang the door bell to the house and, receiving no answer, proceeded between the store and the house and "boltered Vera Lee."

Brock then offered, out of the presence of the jury, the dying declarations of Mrs. Mathis. Burton said when "I got to where she was in a pool of blood between the counter and the

shelves. I asked her what had happened and she said, 'Stanley hit me.'"

Julian at this point, even though the statements were out of the jury's presence, objected. The court denied Julian's objection and another argument emanated, culminating in the court warning Julian, who argued the court's ruling, "Somebody is going to be in contempt of court. When I make a ruling you can appeal it."

Muddy Water Of Soldier's Creek Probed

Langley Adair, County pollution control officer, assured the Sanford Herald this morning that he is investigating complaints of muddy water pouring out of Soldier's Creek into Lake Jessup in the area of the proposed Seminole County park. Adair stated in a telephone conversation that he had taken water samples in the creek as late as Monday and found the turbidity to be within legal limits. This was before Monday's raging rain storm.

The situation was called to Adair's attention last week by a Herald staff writer. At that time he said that he was aware of the condition and had given a verbal warning to Van Hogle and Devlin, developers, to contain their dredging operations in such a manner as to prevent any run off from entering the Creek or the canal.

Another check is being made by the pollution officer today and if a break through is found, he will turn it over to the legal department in Tallahassee for action. If it is determined that a direct discharge into the creek is involved, the United States Army Corps of Engineers will take jurisdiction.

The park at present is undeveloped. However the county commissioners have plans to include bicycle and canoe trails, and other recreational activities.

Adair promised to report the progress made in clearing up the muddy water situation which has long been a source of annoyance to fishermen in the area; Soldier's Creek having been in the past, one of the better fishing spots in Lake Jessup.

Index

Area deaths	1B	Stocks	3A
Bridge	6B	TV	6B
Business review	1C-3C		
Calendar	3A		
Classified ads	8A-9A		
Comics	7B		
Crossword puzzle	6B		
Dr. Crane	7B		
Dear Abby	6B		
Editorial comment	6A		
Entertainment	6B		
Horoscope	6B		
Hospital notes	3A		
Public notices	2A		
Society	5B		
Sports	2B-4B		

Weather

Yesterday's high 94 low 68 with .78 of an inch of rain. Partly cloudy through Wednesday with chance of showers mainly during the afternoon and evening. Highs 86 to 92. Lows 70 to 78. Rain probability 50 per cent today and Wednesday; 30 per cent tonight.

Fair and mild autumn weather dominated most of the nation today.

It's Penney Days.

Important savings for you, your family, your home, and your car. Come early, stay late. It's a rewarding experience.

Every dress shirt in stock.

Sale 4²⁵

Reg. \$5. Men's Dacron polyester-cotton Penn-Prest shirts in assorted prints. Short sleeves, longpoint collar. 14 1/2-17.

Sale 5⁰⁰

Reg. \$9.8. Fashion solid color shirts in polyester-cotton, texturized for comfort. Long sleeve, 2-button cuff in 14 1/2-17.

Sale 6⁵⁰

Reg. \$10. Men's fancy knit shirts of polyester/triacetate. Long sleeve, 2-button cuff in 14 1/2-17.



Sale prices effective thru Saturday.

Knit suit special.

49⁸⁸

Men's polyester knit in solids or fancy patterns. 2-button single-breasted, semi-shaped body and straight leg slacks. 38-46. A great buy.



Men's sportcoat

- men's double knit sport coats
- polyester for no wrinkles
- in patterns or solid blazer look
- a great buy.

Special 24⁸⁸



Power tool sale!

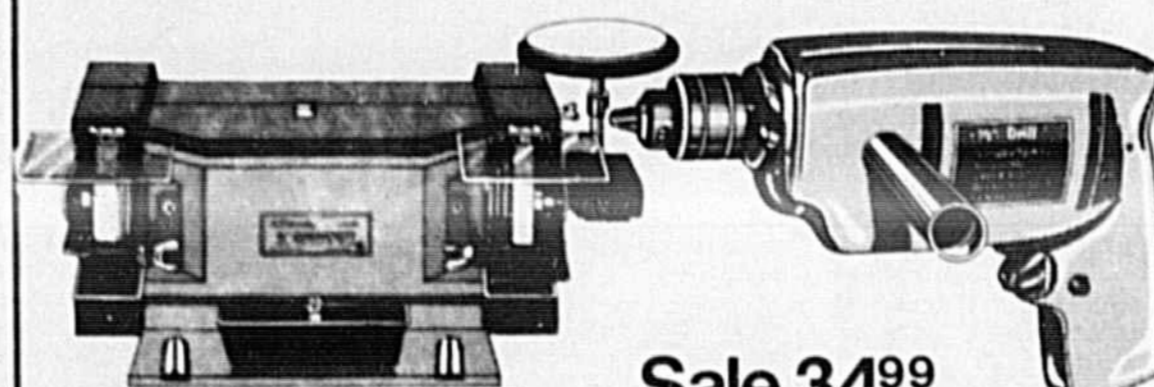

Sale 29⁹⁹

Reg. \$49.9. 6" heavy duty 1/2-HP grinder. Lubricated, oversize bronze bearings, aluminum housing, adjustable tool rests.

Sale 34⁹⁹

Reg. \$39.99. 1/2" Variable speed reversible drill is double insulated for extra protection.

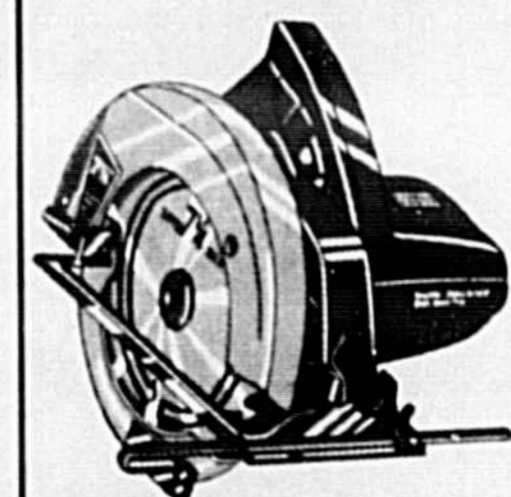

Sale 34⁹⁹

Reg. \$49.9. 7 1/4" circular saw, double insulated, 2.0 HP, security and blade exposure control switch.

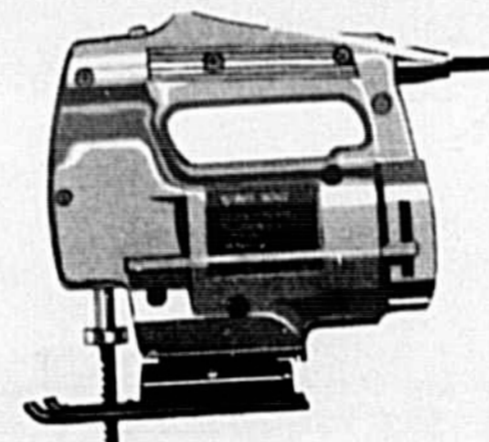

Sale 19⁹⁹

Reg. \$24.99. 2-speed double insulated sabre saw with tilt base. Automatic sawdust blower, 2800 and 3500 strokes per minute.

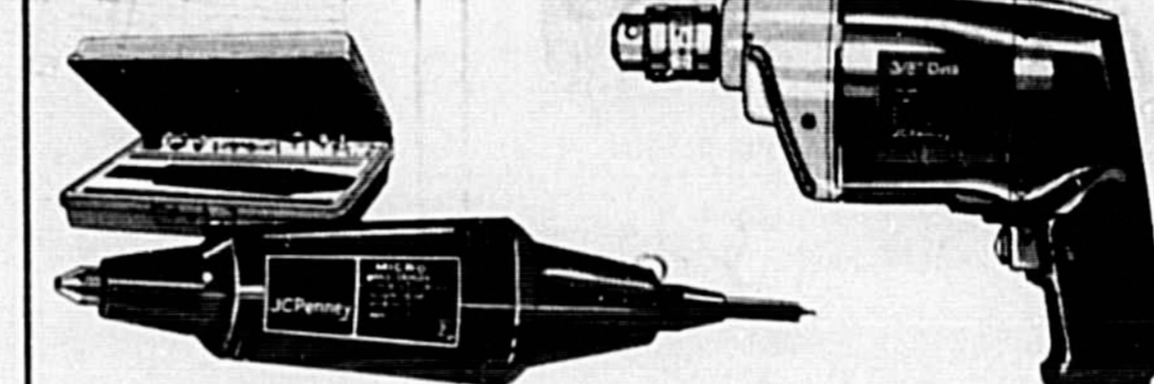

Sale 19⁹⁹

Reg. \$24.99. Micro hand tool kit drills, grinds, polishes. 25,000 RPM. 27 pc. kit.

Sale 19⁹⁹

Reg. \$24.99. 1/2" double insulated, variable speed drill. Trigger controls speed from 0-750 rpm.

Save on "Quick-Release" socket sets.

Sale 59^c each

Reg. 89c each. 1/2" drive open stock sockets. Standard or metric.



Sale 12⁴⁴

Reg. 15.49. Save 3.05 over reg. open stock prices. This 11 pc. socket set includes 1/2" drive quick release ratchet with removable spin-down, 7 1/4" drive sockets 3/8, 1/2" drive ratchet, 3" extension and spark plug socket.

Sale 5⁹⁹

Reg. 7.99. 1/2" drive ratchet with quick release push button and removable spin-down.

Sale prices effective thru Saturday.

You won't find such savings every day, even at Penneys. Except during Penney Days.

15% off girls' tops 'n pants.

Sale 3⁴⁰

Reg. \$4. Polyester/cotton ribbed mock turtleneck top. S, M, L.

Sale 4²⁵

Reg. \$5. Boy-cut cotton corduroy jeans with flare leg. Sizes 7 to 14.

Sale 2⁵⁵

Reg. \$3. Mock turtleneck of Penn-Prest polyester. S, M, L.

Sale 3⁴⁰

Reg. \$4. Gals' cotton denim boy-cut jeans in navy blue only. Sizes 7 to 14.



Women's Polyester/nylon Knit Uniforms. Special. 6⁹⁹

Working girl whites of easy care polyester-nylon knit. Two piece pants sets to machine wash, tumble dry. In junior, petite, junior, misses and half sizes.



15% Off Women's And Junior's Pants

Reg. \$5

Now 4²⁵

Reg. \$7

Now 5⁹⁵

Reg. \$9

Now 7⁶⁵



If you're a pants person, this is the sale for you. Choose from rayon-cotton acrylic and polyester double knit pants. With cuffs and without. Plaid, plain and jacquard knit. With belts or not. Fashion colors for misses and junior sizes.

Save 15% On All Our Quilted Bedspreads!

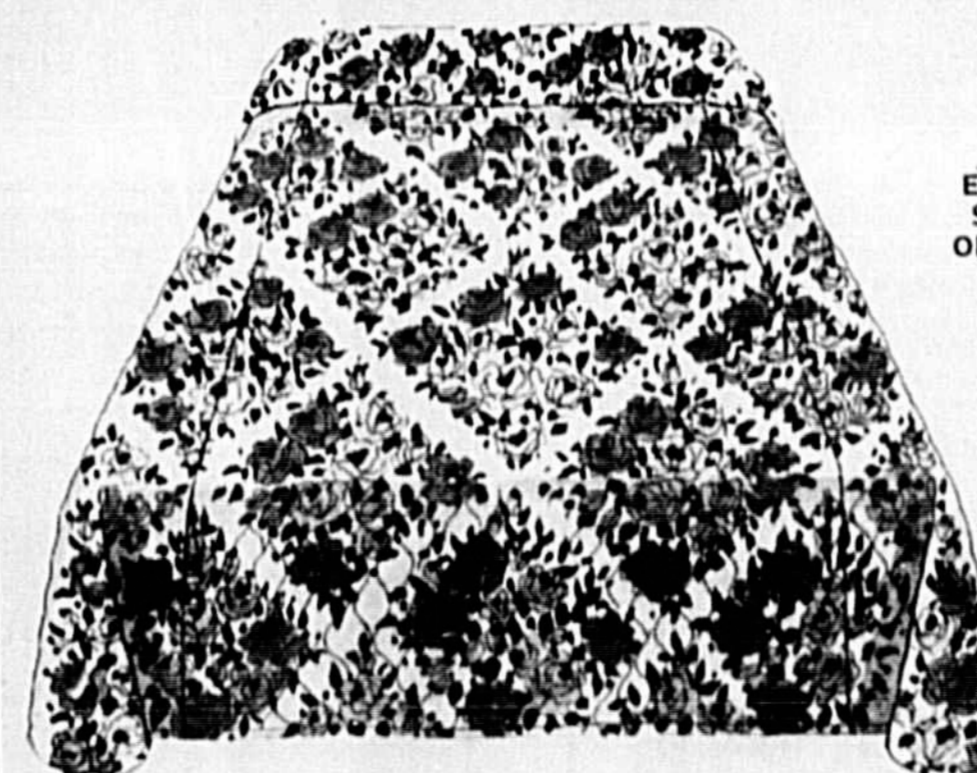

Sale 9³⁵ twin or full

Reg. 10.99. 'Mary Lou' bedspread of acetate with polyester fill. In attractive floral bouquet pattern. Throw style.



Sale \$22⁹⁵ Full

Reg. \$27.00. 'Zenith' bedspread is bouquet floral design. Rayon-acetate with polyester fill and cotton back.

Sale prices effective thru Saturday.

Save 15% On Every Accent Rug, Too.

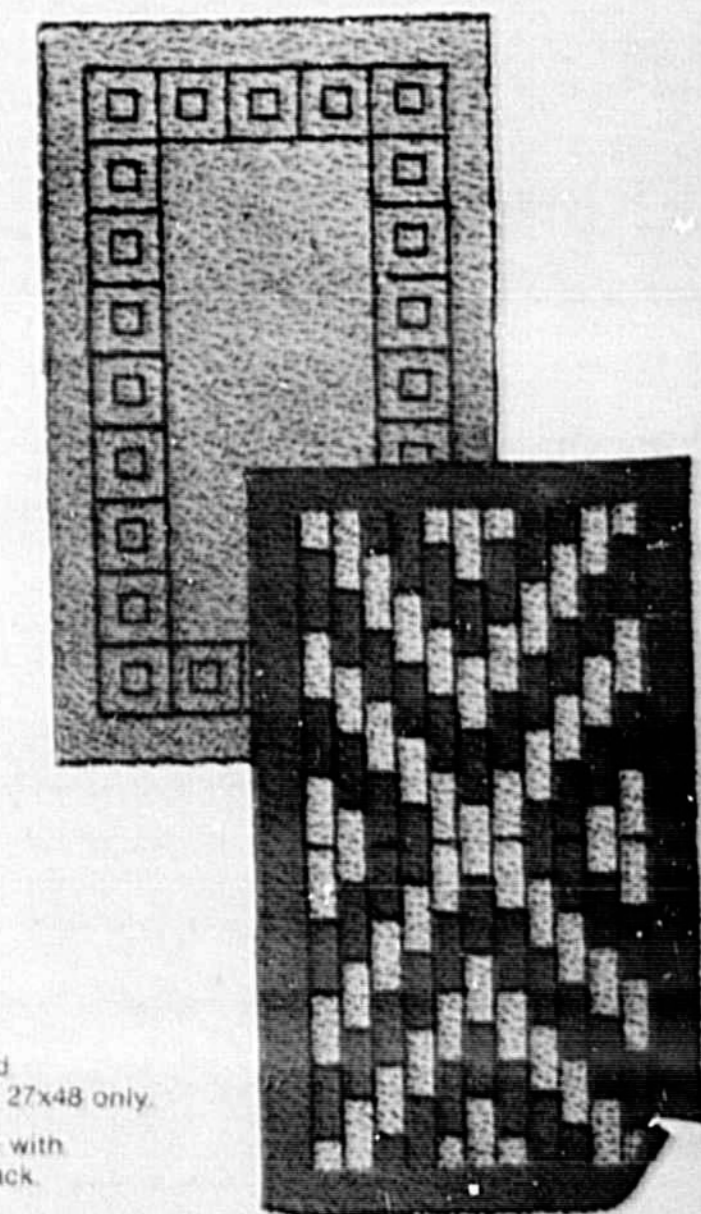

Reg. \$99

Sale 5⁰⁹ 27"x48"

Reg. \$11

Sale 9³⁵ 36"x60"

Our entire line on sale!

'Sparta' is nylon with a classic sculptured geometric border design. Latex backing. 27"x48" only. 'Tivoli' style of Dacron® polyester plush with fringed ends. Non-skid waffled rubber back. 36"x60" only.



CALL 322-1020 FOR OUR CATALOG SERVICE

JCPenney

We know what you're looking for.

"CHARGE IT" at Sanford Plaza Penneys: Shop 10a.m. 'til 9 p.m. Monday thru Saturday. Sanford Plaza Penneys!



CALL 322-1020 FOR OUR CATALOG SERVICE

JCPenney

We know what you're looking for.

Charge It At Sanford Plaza Penneys Open 10 A. M. til 9 P. M. Monday thru Saturday. Sanford Plaza

There's No Parking Problem When You Shop Classified.

WANT AD INFORMATION Direct Phone Lines To Want Ads Seminoles 322-2611 Orlando 831-9993

1 Personal 2 Male Help Wanted 3 Real Estate For Sale 4 Real Estate Wanted 5 Miscellaneous For Sale 6 Musical Merchandise 7 Livestock And Poultry 8 Pets And Supplies 9 Autos For Sale 10 Motorcycles And Scooters 11 Trucks And Trailers 12 Travel Trailers 13 Auto Repairs 14 Pets And Supplies 15 Autos For Sale 16 Motorcycles And Scooters 17 Trucks And Trailers 18 Travel Trailers 19 Auto Repairs 20 Pets And Supplies 21 Autos For Sale 22 Motorcycles And Scooters 23 Trucks And Trailers 24 Travel Trailers 25 Auto Repairs 26 Pets And Supplies 27 Autos For Sale 28 Motorcycles And Scooters 29 Trucks And Trailers 30 Travel Trailers 31 Auto Repairs 32 Pets And Supplies 33 Autos For Sale 34 Motorcycles And Scooters 35 Trucks And Trailers 36 Travel Trailers 37 Auto Repairs 38 Pets And Supplies 39 Autos For Sale 40 Motorcycles And Scooters 41 Trucks And Trailers 42 Travel Trailers 43 Auto Repairs 44 Pets And Supplies 45 Autos For Sale 46 Motorcycles And Scooters 47 Trucks And Trailers 48 Travel Trailers 49 Auto Repairs 50 Pets And Supplies 51 Autos For Sale 52 Motorcycles And Scooters 53 Trucks And Trailers 54 Travel Trailers 55 Auto Repairs 56 Pets And Supplies 57 Autos For Sale 58 Motorcycles And Scooters 59 Trucks And Trailers 60 Travel Trailers 61 Auto Repairs 62 Pets And Supplies 63 Autos For Sale 64 Motorcycles And Scooters 65 Trucks And Trailers 66 Travel Trailers 67 Auto Repairs 68 Pets And Supplies 69 Autos For Sale 70 Motorcycles And Scooters 71 Trucks And Trailers 72 Travel Trailers 73 Auto Repairs 74 Pets And Supplies 75 Autos For Sale 76 Motorcycles And Scooters 77 Trucks And Trailers 78 Travel Trailers 79 Auto Repairs 80 Pets And Supplies 81 Autos For Sale 82 Motorcycles And Scooters 83 Trucks And Trailers 84 Travel Trailers 85 Auto Repairs 86 Pets And Supplies 87 Autos For Sale 88 Motorcycles And Scooters 89 Trucks And Trailers 90 Travel Trailers 91 Auto Repairs 92 Pets And Supplies 93 Autos For Sale 94 Motorcycles And Scooters 95 Trucks And Trailers 96 Travel Trailers 97 Auto Repairs 98 Pets And Supplies 99 Autos For Sale 100 Motorcycles And Scooters 101 Trucks And Trailers 102 Travel Trailers 103 Auto Repairs 104 Pets And Supplies 105 Autos For Sale 106 Motorcycles And Scooters 107 Trucks And Trailers 108 Travel Trailers 109 Auto Repairs 110 Pets And Supplies 111 Autos For Sale 112 Motorcycles And Scooters 113 Trucks And Trailers 114 Travel Trailers 115 Auto Repairs 116 Pets And Supplies 117 Autos For Sale 118 Motorcycles And Scooters 119 Trucks And Trailers 120 Travel Trailers 121 Auto Repairs 122 Pets And Supplies 123 Autos For Sale 124 Motorcycles And Scooters 125 Trucks And Trailers 126 Travel Trailers 127 Auto Repairs 128 Pets And Supplies 129 Autos For Sale 130 Motorcycles And Scooters 131 Trucks And Trailers 132 Travel Trailers 133 Auto Repairs 134 Pets And Supplies 135 Autos For Sale 136 Motorcycles And Scooters 137 Trucks And Trailers 138 Travel Trailers 139 Auto Repairs 140 Pets And Supplies 141 Autos For Sale 142 Motorcycles And Scooters 143 Trucks And Trailers 144 Travel Trailers 145 Auto Repairs 146 Pets And Supplies 147 Autos For Sale 148 Motorcycles And Scooters 149 Trucks And Trailers 150 Travel Trailers 151 Auto Repairs 152 Pets And Supplies 153 Autos For Sale 154 Motorcycles And Scooters 155 Trucks And Trailers 156 Travel Trailers 157 Auto Repairs 158 Pets And Supplies 159 Autos For Sale 160 Motorcycles And Scooters 161 Trucks And Trailers 162 Travel Trailers 163 Auto Repairs 164 Pets And Supplies 165 Autos For Sale 166 Motorcycles And Scooters 167 Trucks And Trailers 168 Travel Trailers 169 Auto Repairs 170 Pets And Supplies 171 Autos For Sale 172 Motorcycles And Scooters 173 Trucks And Trailers 174 Travel Trailers 175 Auto Repairs 176 Pets And Supplies 177 Autos For Sale 178 Motorcycles And Scooters 179 Trucks And Trailers 180 Travel Trailers 181 Auto Repairs 182 Pets And Supplies 183 Autos For Sale 184 Motorcycles And Scooters 185 Trucks And Trailers 186 Travel Trailers 187 Auto Repairs 188 Pets And Supplies 189 Autos For Sale 190 Motorcycles And Scooters 191 Trucks And Trailers 192 Travel Trailers 193 Auto Repairs 194 Pets And Supplies 195 Autos For Sale 196 Motorcycles And Scooters 197 Trucks And Trailers 198 Travel Trailers 199 Auto Repairs 200 Pets And Supplies

Classified Ads Will Find A New Home For Everything — Even For You!

THE BORN LOSER by Art Sansom. A cartoon showing a man losing a bet and a woman winning a bet.

322-2611. A large graphic with the phone number and a small illustration of a person.

Your Direct Line to CLASSIFIED! Call weekdays before 10:00 p.m. or the following day and Saturdays before 12 noon.

THE SHOPPERS GUIDE FOR EVERYONE! The following businesses are listed for your convenience. Permanent residents and newcomers will find this directory the most convenient and up to date way to solve every problem.

SHOP THE EASY WAY! The Shoppers Guide Is Here To Serve You! Air Conditioning, Glass Mirrors, Home Improvements, Appliances, Auto Insurance, etc.

Payton. Real estate listings in the Payton area, including homes for sale and rental properties.

SOUTH PINECREST. Real estate listings in the South Pinecrest area, including homes for sale and rental properties.

RAVENNA PARK. Real estate listings in the Ravenna Park area, including homes for sale and rental properties.

RETIREMENT HOME. Real estate listings for retirement homes, including amenities and location details.

MAYFAIR. Real estate listings in the Mayfair area, including homes for sale and rental properties.

GROVE MANOR. Real estate listings in the Grove Manor area, including homes for sale and rental properties.

RAVENNA PARK. Real estate listings in the Ravenna Park area, including homes for sale and rental properties.

RETIREMENT HOME. Real estate listings for retirement homes, including amenities and location details.

MAYFAIR. Real estate listings in the Mayfair area, including homes for sale and rental properties.

GROVE MANOR. Real estate listings in the Grove Manor area, including homes for sale and rental properties.

RAVENNA PARK. Real estate listings in the Ravenna Park area, including homes for sale and rental properties.

Mr. Businessman: Were You Included in the HERALD'S Honor Roll of the Progress Edition Last Year? A large advertisement for the Herald's Honor Roll.

HONOR ROLL. A list of names and addresses of individuals who were included in the Herald's Honor Roll.

Mr. Businessman: Were You Included in the HERALD'S Honor Roll of the Progress Edition Last Year? A large advertisement for the Herald's Honor Roll.

HONOR ROLL. A list of names and addresses of individuals who were included in the Herald's Honor Roll.

Mr. Businessman: Were You Included in the HERALD'S Honor Roll of the Progress Edition Last Year? A large advertisement for the Herald's Honor Roll.

HONOR ROLL. A list of names and addresses of individuals who were included in the Herald's Honor Roll.

Mr. Businessman: Were You Included in the HERALD'S Honor Roll of the Progress Edition Last Year? A large advertisement for the Herald's Honor Roll.

HONOR ROLL. A list of names and addresses of individuals who were included in the Herald's Honor Roll.

Mr. Businessman: Were You Included in the HERALD'S Honor Roll of the Progress Edition Last Year? A large advertisement for the Herald's Honor Roll.

HONOR ROLL. A list of names and addresses of individuals who were included in the Herald's Honor Roll.

Mr. Businessman: Were You Included in the HERALD'S Honor Roll of the Progress Edition Last Year? A large advertisement for the Herald's Honor Roll.

THE ARMY RESERVE. Experienced help needed. IT PAYS TO GO TO MEETINGS. A large advertisement for the Army Reserve.

THE ARMY RESERVE. Experienced help needed. IT PAYS TO GO TO MEETINGS. A large advertisement for the Army Reserve.

THE ARMY RESERVE. Experienced help needed. IT PAYS TO GO TO MEETINGS. A large advertisement for the Army Reserve.

THE ARMY RESERVE. Experienced help needed. IT PAYS TO GO TO MEETINGS. A large advertisement for the Army Reserve.

THE ARMY RESERVE. Experienced help needed. IT PAYS TO GO TO MEETINGS. A large advertisement for the Army Reserve.

THE ARMY RESERVE. Experienced help needed. IT PAYS TO GO TO MEETINGS. A large advertisement for the Army Reserve.

THE ARMY RESERVE. Experienced help needed. IT PAYS TO GO TO MEETINGS. A large advertisement for the Army Reserve.

THE OTHER BANKS WON'T LIKE THIS AD, BUT YOU WILL. WE'VE ELIMINATED THE \$200 CATCH IN FREE CHECKING.



In all the ballyhoo about "Free Checking Accounts" in Winter Park and Orlando, it could be that you missed The \$200 Catch.

Here it is: Most of the ads say something like "you must maintain a minimum balance of \$200."

That's bank talk for "either \$200 of your money remains in the bank, or your free checking isn't free."

Now, this strikes us as a bit unfair.

So as of now, we're eliminating all our personal checking service charges. No if's, and's or but's.

All we ask is that you keep enough money in your account to cover your checks.

If you have an account with us, you won't have to pay another penny in service charges.

If you don't, this is a good reason to switch. Just stop in and we'll handle the paper work in minutes.

Since we want your business for a lifetime, we're sure not about to keep you waiting now.



Now at these five Barnett Banks in Winter Park / Orlando: Downtown Winter Park, 17-92 at Lee Road, Altamonte Springs, East Orlando, West Orlando.



CAMBODIAN SOLDIERS kneel to quench their thirst with muddy water from mortar blast holes about 10 miles south of Phnom Penh, the capital.

F111 Pulled From Combat; F4 Phantoms Pound Reds

Base, 300 miles northeast of Bangkok, killing a Thai sentry and wounding two Americans and two Thais. One terrorist was reported killed, and one captured in the raid, the second in 24 hours against U.S. bases in Thailand. Udon Air Base, 200 miles southeast of Udon, came under mortar attack Sunday night. The U.S. Command refused to officially acknowledge the reports, which came from reliable sources, that the \$9 million F111 planes had been withdrawn from combat after the loss of one with two crewmen aboard Thursday. Less than a dozen bombing missions were flown by the F111s which had just returned to the war zone after a four-year absence, sources said. "We have no comment," said a Command spokesman, refusing to confirm or deny the reports. The informants also said that although the Command withheld reporting the F111 loss because a search and rescue effort was under way, the Air Force actually did not know where the plane went down and heard any emergency radio signals from the two crewmen which would have pinpointed their position. The loss of the F111 was common knowledge among newsmen, and had been reported by some Western news agencies from Bangkok as well as by Radio Hanoi last week. But the U.S. Command kept an embargo on reporters in Saigon, who were under penalty of being discredited. The U.S. Command issued only a brief statement on the loss of the F111, the fourth loss in the war zone since they first came to Vietnam in March 1968. Spokesmen refused to say whether the remaining F111s ordered to Southeast Asia would continue to be replaced and if the F4 wing they are replacing would continue its rotation to the United States as had been originally planned.

Welfare Recipient Faces Opium Charges

By MARION BETHA
A recipient of county welfare, charged with possession of opium, appeared at arraignment this morning before Circuit Judge Dominick Salli. Rebecca Robinson entered a not guilty plea to charges of possession of a barbiturate and possession of a narcotic drug (Opium) and trial is set for the week of Nov. 27. A co-defendant in the case, Lester Watson, told the court he is living with the woman and is a "day worker" earning \$50 weekly. His trial is set for the same week, following an innocent plea.

Seminole Meet Set For Orange

By BILL SCOTT
The scheduling of an Oct. 12 noon meeting between Seminole County municipal officials and major developers of building projects now under construction in Seminole, at an Orange County restaurant, has aroused the curiosity of at least two Sanford city commissioners. Mayor Lee P. Moore and Commissioner Julian Stenstrom questioned why the session was set at Howard Johnson's Theatre - in the Lounge at 14 and Lee Road intersection, when only Seminole is concerned.

Stenstrom "was concerned" since he felt the proceeds from the "dutch" luncheon should go to a Seminole eatery. "It's taking money out of the county," Stenstrom added. Mayor Moore mentioned the meeting at Monday afternoon's City Commission work session and wondered why the meeting was arranged outside the county. This morning, The Herald contacted Greg Drummond, County Commission chairman,

and writer of the invitation, to ask why Orange County? Drummond replied the Orange location was made for the convenience of the land developers. The commission chairman declined to disclose the agenda of the session but advised the press could attend. "Any advance information on this is being withheld," Drummond explained, "since I want it to be fresh."

In his letter to city officials, the County Commission chairman reflected on the recent impact in Central Florida of population growth and pointed out these new citizens "are accompanied by disproportionate demands upon public services and facilities."

Drummond's letter continued: "Rather than adopt the negative approach that all growth should be stopped, a positive attitude must be maintained. It is therefore incumbent upon public officials and the developers of Seminole County to work in concert in devising constructive solutions to this dilemma."

Drummond's letter continued: "Rather than adopt the negative approach that all growth should be stopped, a positive attitude must be maintained. It is therefore incumbent upon public officials and the developers of Seminole County to work in concert in devising constructive solutions to this dilemma."

Drummond's letter continued: "Rather than adopt the negative approach that all growth should be stopped, a positive attitude must be maintained. It is therefore incumbent upon public officials and the developers of Seminole County to work in concert in devising constructive solutions to this dilemma."



THE CALM BEFORE THE BLASTOFF is captured in reflective view of the Apollo 17 space vehicle assembly building at Cape Kennedy's Complex 39A. The Saturn Booster will lift astronaut Eugene A. Cernan, Ronald E. Evans and Harrison H. Schmitt toward the moon Dec. 6.

McGovern Builds Corruption Claim

By WALTER R. MEARS
NEW YORK (AP) — Sen. George McGovern is escalating allegations of White House corruption, saying government scandals of the past were "child's play compared to what's going on in this administration." The Democratic presidential nominee evidently has decided to make that a major theme in what he said will be an all-out campaign against President Nixon during the five weeks until election day. McGovern is campaigning today in New York and Boston after asserting that, while the President talks of law and order, "I submit (that) the permissiveness toward a breakdown of high moral standards in this country begins right with Richard Nixon and Spiro Agnew."

Area Deaths

- MISS HAZEL OLDAKER: Miss Hazel I. Oldaker, 79, of Culpeper, Va., died Monday. Born in Crawfordsville, Ind. She was a frequent visitor to Sanford. She was a Methodist. She is survived by brother, Glenn Oldaker, of Culpeper; nephew, Guy B. Oldaker, Springfield, Va. and niece, Mrs. Kathleen Pezold, Sanford.
- MRS. ELSIE HUBLEY: Mrs. Elsie Louise Hubley, 69, of 804 Mulberry Ave., Sanford, died Saturday at local hospital. Born in Pennsylvania, she came here in 1967 from Cleveland, Ohio and was a member of Congregational Christian Church and the Ethel Root Circle.
- JOHN DEMPSEY: John Patrick Dempsey, 57, of 2888 Palmetto Ave., died Monday at Seminole Memorial Hospital. He was a native of New York City and came to Sanford a year ago. He was Catholic and a retired longshoreman. He is survived by a wife, Mrs. Mae Dempsey, daughter, Mrs. Harriett Schmidt of New York City, three sons, Richard, Dennis, and James Dempsey all of New York City; two sisters, Mrs. Genevieve Baumister, Sanford; Mrs. Lillian Izzo, Hollywood, Fla.; mother, Mrs. Charlotte Dempsey, Sanford and eight grandchildren.
- MRS. MINNIE SCOTT: Mrs. Minnie Scott, 85, Wilbur Avenue, Lake Mary died Monday. Born in Leslie, Ky., she had lived in Lake Mary for the past 17 years. She was a member of the First Baptist Church of Lake Mary. Survivors are two sons, Ralph and Damon, both of Lake Mary, five grandchildren and seven great-grandchildren. Body will be set to Stewart, Va., for services and burial. Brissson Funeral Home in charge of local arrangements.
- LT. COL. PAUL BISSELL: Lt. Col. (Ret.) Paul L. Bissell, 81, of Lake Mary died Monday at Florida Hospital, Orlando. Born in Charleston, S. C., he was a son of Deville and Carrie Glover LaFar Bissell and had lived in Lake Mary for the past 20 years. He had served in the Air Force during both World Wars and was a graduate of Princeton University and Rollins College. Between the wars he was an illustrator and information specialist in New York City and with the Federal Government in Washington, D. C. Survivors include his widow, Mrs. Evelyn Jordan, Sanford. Funeral services and burial will be in Johnson City, Tenn. Brissson Funeral Home is in charge.
- MRS. ELSIE HUBLEY: Mrs. Elsie Louise Hubley, 69, of 804 Mulberry Ave., Sanford, died Saturday at local hospital. Born in Pennsylvania, she came here in 1967 from Cleveland, Ohio and was a member of Congregational Christian Church and the Ethel Root Circle.

WHERE THEY STAND THE ISSUES OF THE 1972 CAMPAIGN Vietnam War

REPUBLICANS: We will continue to seek a settlement of the Vietnam war which will permit the people of Southeast Asia to live in peace under political arrangements of their own choosing. We believe that the President's proposal — to withdraw remaining American forces from Vietnam four months after an internationally supervised cease-fire has gone into effect throughout Indo-China and all prisoners have been returned — is as generous an offer as can be made by anyone — by anyone that is, who is not bemused with surrender. We insist that, before all American forces are withdrawn from Vietnam, American prisoners must be returned and a full accounting made of the missing in action and of those who have died in enemy hands.

DEMOCRATS: Immediate and complete withdrawal of all U.S. forces in Indo-China and an end to all U.S. military action in Southeast Asia — with this proviso: We must insist that any resolution of the war include the return of all prisoners held by North Vietnam and other adversary forces, and the fullest possible accounting for the missing. After the end of U.S. direct-combat participation, military aid to the Saigon Government, as elsewhere in Indo-China, will be terminated, but humanitarian assistance will be offered to the people of Vietnam to help them repair the ravages of war.



ALEX LEVINE of Geneva, driver of this car, was charged with reckless driving and driving while intoxicated by officer James Wolford of the Oviedo Police Department. Mentril Martin of Oviedo was the driver of the other car involved in the accident on SR 419 in downtown Oviedo. Both cars were total losses. (Greg Sindad Photo)

Meet Our Staff



When Service Matters
BRISSON FUNERAL HOME
OLDEST FUNERAL HOME IN SEMINOLE COUNTY
FIRST ESTABLISHED IN 1885



'Spirits Real High' 'New' Seminoles Prepare For Kathleen

By GARY TAYLOR
Herald Sports Editor

The new Fighting Seminoles hit the practice field for the first time yesterday afternoon, under the direction of new head coach Bill Young.

Young reported a lot of enthusiasm among the players and "spirits real high." The Tribe is preparing for a Thursday night meeting with the Lakeland Kathleen Red Devils. That game is scheduled for 8 p.m. in Lakeland.

Young took over the reins of the team yesterday, but reported "things will be basically the same" as far as plays and such are concerned.

Much of Monday's session was spent trying to get organized, to "get the boys working" toward the same goal. "There may be some old faces back on the team this Thursday night. Young reported that some players that had left the team for various reasons had been given a chance to come back."

"We thought they might want to play." Passing seems to be the key to this Thursday night's game in Lakeland. It will be important in two aspects. The Seminoles need to improve their passing game and stop Kathleen's Young expects Kathleen to pass about 90 per cent of the time. A few players have been shifted to other positions and a good number

will play both offense and defense. As part of the effort to stop the Kathleen passing game, offensive backs Bruce Philpot and Mike Roberts have been moved to the defensive secondary and will likely see action at both positions.

Young feels the key to improving the Sanford passing attack is the offensive line. Two players who have seen considerable action on defense will also be on the offensive line. Dickie Deas will be shifted to offensive tackle and Jim Steffens will see action at center.

Young felt the defense did especially good in the first half against Winter Park Friday night. He also pointed out that quarterback Brent Carlil did a good job running for his life."

Hopefully the improvements on the offensive line will give Carlil a little more time to get his passes off and an improved passing game will help make the running game effective.

One thing against the Seminoles is the short amount of time they have to prepare for the tilt. "Playing on Thursday is going to hurt us quite a bit against Kathleen. We could really use another day."

Young feels he'll carry an "improved" team to Lakeland Thursday night and they'll be ready to tackle the tough Kathleen opponents.

Seminole is currently 1-0 while Kathleen is 2-0. This will be the Red Devils' first Big Eight Conference encounter, while the Seminoles stand 0-1 in loop play.



FOOTBALL PLAYERS at Seminole High met with their new head coach, Bill Young, during a special assembly Monday morning. Shown at the meeting are (left to right) Turner Davis, Brent Carlil, Willie Scott, principal Jack Redding, Young, Alan Myers and Fred Dunn.

Clemente Could Be Difference

By GARY MIHOCCS
Associated Press Sports Writer

PITTSBURGH (AP) — Visiting players and managers have given varied opinions to the unanswerable question of who will win the National League playoffs which begin here this weekend.

World Series when he wanted to go to the West was the best—yo see what he does." At least one manager, Don Zimmer of the San Diego Padres, wants the Reds.

"I'll take Cincinnati," he declares. "Of course, they're both great clubs, but I believe Cincinnati has a little better defense."

Carl Morton, Montreal pitcher, had another angle. "If both teams play their best, it's just going to be a matter of who gets the breaks. But if they are off a little bit, I pick Pittsburgh because of their depth in hitting."

Depth is a Pirate asset, but Walter Alton, veteran manager of the Los Angeles Dodgers, questioned its value in the short series.

"The Pirates have a fine 25-man team, but you can only play nine at a time," he said. "And it's a short series."

Lyman Is One Few Surprises In Metro Loop

By HERKY CUSH
Herald Sports Writer

Preseason predictions and run downs are really nice. They often give one an insight as to the upcoming season and just who will be up among the contenders in the coming season. At least this is the case most of the time.

The preseason selections in the Metro Conference centered around the defending champion Winter Park and at this stage of the season the Wildcats are pretty much following to form.

But they are the only eleven that is as the Metro race has been turned into a two team battle between an upstart in recent years (the Wildcats) and the old perennial favorite (Edgewater).

Larry Gergely's Winter Park crew has been gaining momentum in its three outings to date and appear unstoppable at this stage of the season. They have posted back to back shutouts, the latest being a 3-0 win over Sanford.

Edgewater, with only four regulars back from last year, was not supposed to be much of a threat in the Metro this season. But after three games the Eagles are flying high as usual. Bob Dolce's crew is another of the tough defensive units in the Metro, having allowed only one touchdown in three games. But a lack of offense may curtail the Eagles' aspirations for the Metro Crown. While they've allowed an average of only two points a game they have registered an average of around 12 points per outing. In two of their three games they've only managed one touchdown but have had the staunch defense.

Dick Copeland's Lyman Greyhounds are another of the surprise teams but not in the same manner as Edgewater and Bishop Moore. After posting the impressive victory over Colonial the Hounds have not looked the same. They barely edged Mainland 21-20 and could not generate anything in the way of an offense in losing to Bishop Moore.

The fronton opened yesterday with over 4,000 fans attending two performances.

The Orlando-Seminole Jai-Alai fronton is showing through his practice paces at the Fronton which is located at Fern Park-Casselberry. The Fronton opened yesterday with over 4,000 fans attending two performances.

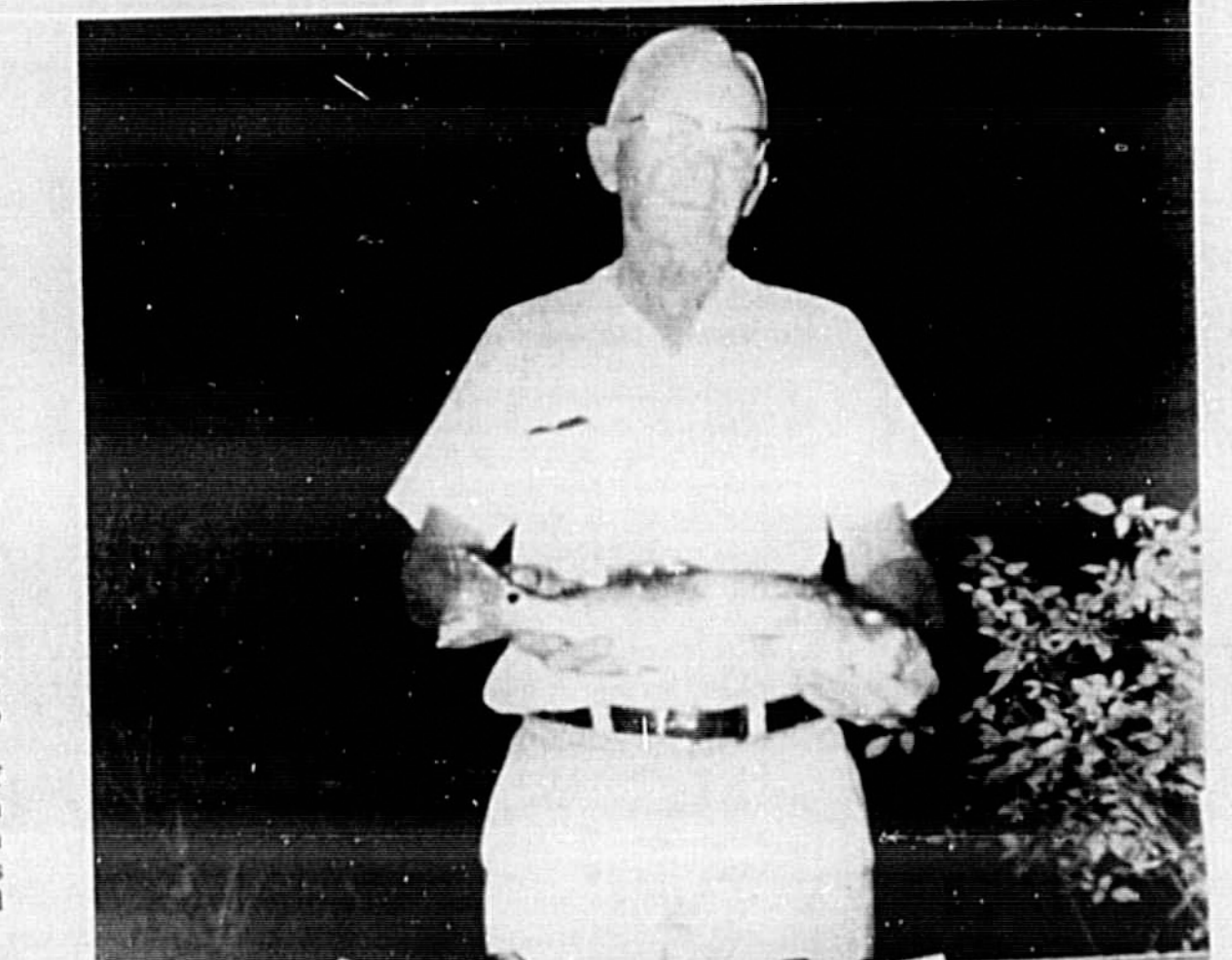

WHO SAYS you have to go to the ocean for salt water fish? Bruce Orrell, formerly of Florida and now living in the Ozarks, Missouri, landed this salt water channel bass 100 miles from salt water. Orrell was fishing in the St. Johns River near DeLand when he made the unusual catch.

Flag Defenses Shine

Defenses continued to sparkle in the Sanford Recreation Department's Flag Football league with three shutouts being recorded. Actually a scoreless tie was among the results of last week with the victor decided by yardage.

The Rams were awarded a 1-0 victory over the Cowboys after their game finished in a scoreless tie. The game went into a playoff situation after regulation time had expired.

Each team was given five more downs to move the ball and the team with the most yardage was declared the winner. That was the Rams.

Rebounding from an opening week defeat the Jayhawks came on to defeat the Packers by a 12-0 count. The victors put a touchdown on the board in each half.

The first Jayhawk touchdown resulted when Rocky Jerigan went around left end on a one yard dash. Jerigan also had a hand in the second touchdown in the second half. The second score was a little more spectacular with Jerigan connecting with Justin Hunt on a 70 yard pass-run play.

The other game found the Wildcats blanking the Bulldogs by a 12-0 score. Both the Wildcats touchdowns were from far on one, on a pass and the other a long run.

Opening the scoring in the first half was 80 yard pass-run play from quarterback Paul Glan to Don Lively. Lively also scored the second touchdown, streaking 60 yards on a double reverse around left end.

This week's game have the Wildcats and Packers in the 9 a.m. game; the Hams meeting the Bulldogs at 10 a.m. and the Cowboys and Jayhawks squaring off at 11.

Salt Water Report

Ocean fishing has been so poor for the past week as to verge on pitiful. Striped bass have not been running because of lack of shrimp, therefore, no tarpon. Standings in the H.F.C. Tarpon Rodeo remain the same as no entries were weighed in.

The few deep sea boats out had only small snapper to show for their efforts with most of them being caught on the new count reef. The west wind died the water around the jeties and in the inlet causing fish to move out.

Fier fishing was excellent until Saturday with Merle Keller at the Main Street spot recording channel bass up to 27 pounds and many smaller ones. Blues and flounders were good all week, with a few hitting, drum, and sheepshead for variety.

Bluefish catches averaged about 100 per day on the Ormond pier along with founder and Spanish mackerel up to four pounds but Saturday's rain spoiled the water and to fishing fell off. The new Lanes Club chapter of Ormond-By-the-Sea will run the pier next Saturday and all proceeds for the day will go toward the Seeing Eye Dog Project sponsored by the Lions.

Small pompano, a few Spanish mackerel, lots of whiting, scattered blues and channel bass comprised the take at Sun-Glow Pier according to Jean Opel, manager. A good north-northwest wind for a few days should bring the large schools of bluish within reach of the surf casters as October is the month for the Fall migration to hit its peak. Channel bass have hit well south of New Smyrna for two weeks for the "long rod" men. A 20 pounder fell to John Fisher according to a note from Seminole Sporting Goods Store. Don Smith, manager, mentioned that Fischer was using a live fingerling mullet in his bait when the big one hit.

The "Fisher" Hole Tackle Shop, Daytona, had basically the same reports as last week. Bridge fishermen are hitting some nice trout in the early a.m. from both the Ormond and Broadway bridges. Flugs are getting their share with the "Doll Ya-hoo" by far the favorite. Tomoka Basin is full of trout, channel bass, and snook, live shrimp playing the best catches. — LETS GO FISHING!



JERRY McADAMS had a variety on his stringer after his recent trip to Camp Seminole. Among the fish on his stringer were catfish, panfish and red breast. McAdams was using mussels as bait.



FINDING BASS was not a hard trick for Tommy Bennett at left and Richard Stevens who landed this stringer while at a recent trip out of Camp Seminole. The pair was using a Ripala lure to attract their bass.

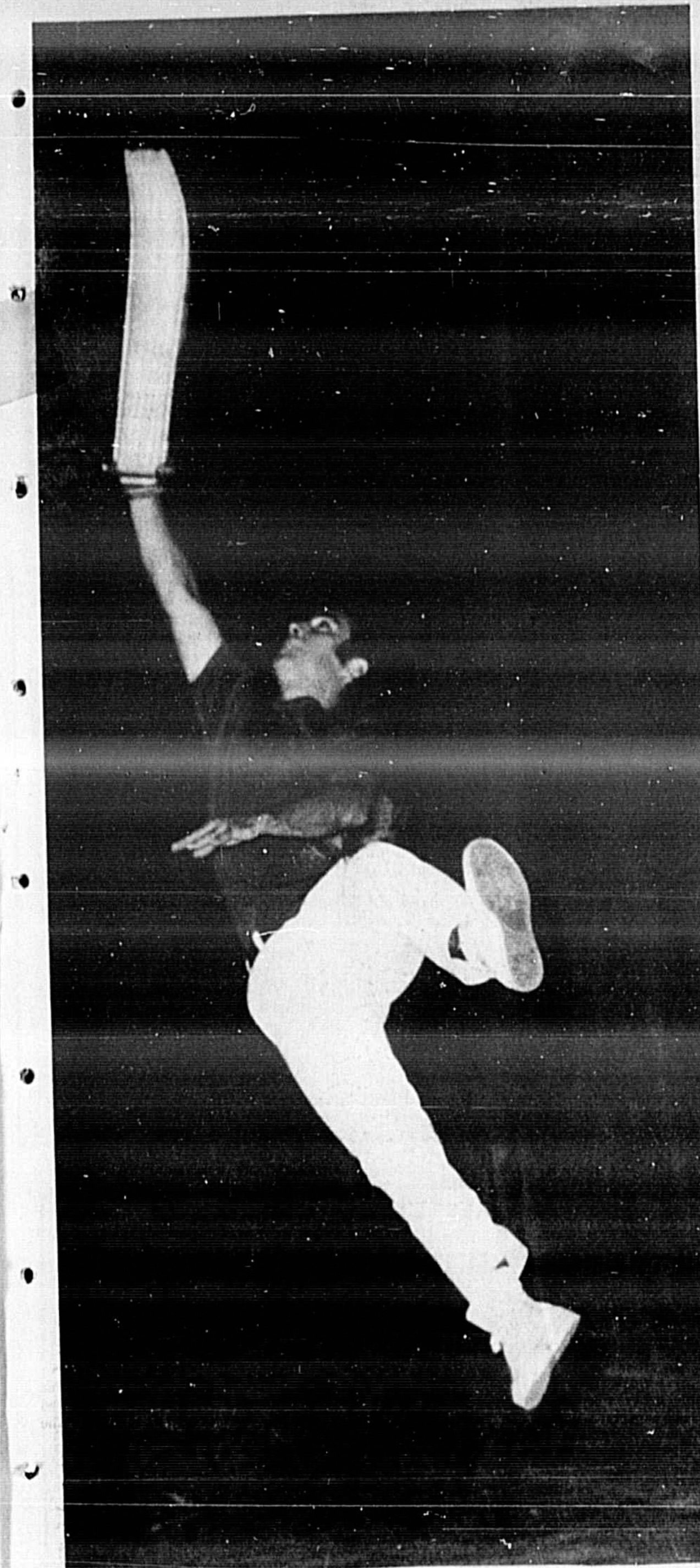

AMONG THE regulars at the Orlando-Seminole Jai Alai Fronton is Fernin who is shown going through his practice paces at the Fronton which is located at Fern Park-Casselberry. The Fronton opened yesterday with over 4,000 fans attending two performances.

Jai-Alai Attendance Fair At Opening Day

The Orlando-Seminole Jai-Alai fronton attracted 4,259 people who wagered \$225,566 for the opening day matinee-night double-header. A fine crowd of 1,745 was on hand for the matinee, wagering \$105,321.

The attendance and mutual handle for the night performance was much lower than expected, with 2,614 Jai-Alai fans showing up to be \$120,245.

The 24th returned in the eighth game perfecting \$219, while the 8 quinnella in the third game paid \$59.40.

Juan and Laca recorded three wins each during the opening day two-bills. Eight players had a pair of wins each. They were Altuna, Losa, Arte, Augustine, Angel, Jose, Pedrosa and Maruri.

There were three players playing at the Orlando-Seminole fronton for the first time. Pena, Losa and Bengio II

Tuesday Night Entries

The top perfecta of the afternoon performance came in the final game, with lucky 4-6 ticket holders collecting \$218. The 4-3 paid \$211.80 in the third and the 4-3 returned \$201 in the fifth for perfecta wagering.

The third game 4-5 combination paid \$61.20 for a quinnella, while the fifth game was a 3-4 paying \$55.80. The biggest on payoff came in the second game, with Maruri-Gandi paying \$20.20 in post seven.

The daily double on games 11 and 12 of the night performance was a 1-7 combination returning \$77.40. The daily double on games three and four paid \$210.30 for the 8-4 combination and the 2-1 paid \$145.50 for the daily double on the first two games.

Tonight's Entries
FIRST GAME — Doubles, Spectacular Seven: 1. Sala Zarré; 2. Liza Yisa; 3. Maruri Jose; 4. Arte; 5. Erdoza Basidi; 6. Angel Bengio II; 7. Revé Bengio II; 8. Arte Gargallo; 9. Bengio II; 10. Bengio II; 11. Bengio II; 12. Bengio II.
SECOND GAME — Doubles, Spectacular Seven: 1. Liza Zarré; 2. Erdoza Jose; 3. Sala Yisa; 4. Angel Bengio II; 5. Ibarra Tonia; 6. Maruri Basidi; 7. Revé Bengio II; 8. Arte Gargallo; 9. Bengio II; 10. Bengio II; 11. Bengio II; 12. Bengio II.
THIRD GAME — Doubles, Spectacular Seven: 1. Arte Jose; 2. Revé Bengio II; 3. Sala Yisa; 4. Angel Bengio II; 5. Ibarra Tonia; 6. Maruri Basidi; 7. Revé Bengio II; 8. Arte Gargallo; 9. Bengio II; 10. Bengio II; 11. Bengio II; 12. Bengio II.
FOURTH GAME — Doubles, Spectacular Seven: 1. Arte Jose; 2. Revé Bengio II; 3. Sala Yisa; 4. Angel Bengio II; 5. Ibarra Tonia; 6. Maruri Basidi; 7. Revé Bengio II; 8. Arte Gargallo; 9. Bengio II; 10. Bengio II; 11. Bengio II; 12. Bengio II.
FIFTH GAME — Doubles, Spectacular Seven: 1. Arte Jose; 2. Revé Bengio II; 3. Sala Yisa; 4. Angel Bengio II; 5. Ibarra Tonia; 6. Maruri Basidi; 7. Revé Bengio II; 8. Arte Gargallo; 9. Bengio II; 10. Bengio II; 11. Bengio II; 12. Bengio II.
SIXTH GAME — Doubles, Spectacular Seven: 1. Arte Jose; 2. Revé Bengio II; 3. Sala Yisa; 4. Angel Bengio II; 5. Ibarra Tonia; 6. Maruri Basidi; 7. Revé Bengio II; 8. Arte Gargallo; 9. Bengio II; 10. Bengio II; 11. Bengio II; 12. Bengio II.
SEVENTH GAME — Doubles, Spectacular Seven: 1. Arte Jose; 2. Revé Bengio II; 3. Sala Yisa; 4. Angel Bengio II; 5. Ibarra Tonia; 6. Maruri Basidi; 7. Revé Bengio II; 8. Arte Gargallo; 9. Bengio II; 10. Bengio II; 11. Bengio II; 12. Bengio II.
EIGHTH GAME — Doubles, Spectacular Seven: 1. Arte Jose; 2. Revé Bengio II; 3. Sala Yisa; 4. Angel Bengio II; 5. Ibarra Tonia; 6. Maruri Basidi; 7. Revé Bengio II; 8. Arte Gargallo; 9. Bengio II; 10. Bengio II; 11. Bengio II; 12. Bengio II.
NINTH GAME — Doubles, Spectacular Seven: 1. Arte Jose; 2. Revé Bengio II; 3. Sala Yisa; 4. Angel Bengio II; 5. Ibarra Tonia; 6. Maruri Basidi; 7. Revé Bengio II; 8. Arte Gargallo; 9. Bengio II; 10. Bengio II; 11. Bengio II; 12. Bengio II.
TENTH GAME — Doubles, Spectacular Seven: 1. Arte Jose; 2. Revé Bengio II; 3. Sala Yisa; 4. Angel Bengio II; 5. Ibarra Tonia; 6. Maruri Basidi; 7. Revé Bengio II; 8. Arte Gargallo; 9. Bengio II; 10. Bengio II; 11. Bengio II; 12. Bengio II.
ELEVENTH GAME — Doubles, Spectacular Seven: 1. Arte Jose; 2. Revé Bengio II; 3. Sala Yisa; 4. Angel Bengio II; 5. Ibarra Tonia; 6. Maruri Basidi; 7. Revé Bengio II; 8. Arte Gargallo; 9. Bengio II; 10. Bengio II; 11. Bengio II; 12. Bengio II.
TWELFTH GAME — Doubles, Spectacular Seven: 1. Arte Jose; 2. Revé Bengio II; 3. Sala Yisa; 4. Angel Bengio II; 5. Ibarra Tonia; 6. Maruri Basidi; 7. Revé Bengio II; 8. Arte Gargallo; 9. Bengio II; 10. Bengio II; 11. Bengio II; 12. Bengio II.

Need Two Wins Red Sox Relying On Tiant

By HAL BOKS
Associated Press Sports Writer

Luis Tiant, Boston's goateed right-hander, carries the fate of the Red Sox in baseball's American League East showdown with him tonight when he pitches "the most important game of my life," against Detroit.

The Sox just hope he doesn't slip. It was a disastrous slip by usually sure-footed Luis Aparicio that short-circuited a Boston rally Monday night and when Detroit went on to whip the Sox 4-1, it left the Sox peering into oblivion. One more Detroit victory either tonight or Wednesday will spell title for the Tigers.

While Detroit was getting the jump on Boston in their head-to-head confrontation for the AL East flag, Montreal's Bill Stoneman stole some of the spotlight with the second no-hitter of his major league career, defeating the New York Mets 7-0 in the first game of a twilight doubleheader. The Mets won the second game, 2-1.

Elsewhere on an abbreviated schedule Monday, the Chicago Cubs defeated Philadelphia 4-3 in the National League. Milwaukee won New York Yankee 6-1 and the Chicago White Sox tripped Minnesota 6-4 in the American League.

Mickey Lolich struck out 15 batters and limited Boston to six hits while Aurelio Rodriguez drove in three runs for the Tigers with a homer and two singles. Al Kaline also had a homer and two other hits.

Kaline had given Detroit the lead in the first inning, with his 10th homer of the year and third in the last three games and Detroit went on to get to the top of the third. Tommy Harper singled and reached third on Aparicio's hit. Then Carl Yastrzemski laced a 420-foot drive that scored Harper and sent Aparicio around third, headed for home.

There he met Yastrzemski and the Tigers tagged Yax for the second out of the inning. Then Lolich struck out Reggie Smith to end the threat.

After that, the ball game belonged to Lolich, Kaline and Rodriguez. In the fifth, Rodriguez homered. In the sixth, Kaline singled and came around to score on a hit by Rodriguez. In the eighth, Kaline singled again and again the Tigers scored on a two-out single by Rodriguez.

The Detroit-Boston showdown was topped on the 10th, when the Philadelphia Eagles and their owner, Leonard Tose, eat humble pie Monday night. It was in doing his thing on national television (ABC). His thing was 12 of 19 pass completions for 164 yards and three touchdowns. He led the Giants to a 17-12 victory over the winless Eagles.

Johnston, the 205-pound running back who sat out most of last season's season with an injured knee, caused all three of Snead's TD passes, and ran the ball 36 times for 123 yards and the fourth touchdown. It was the first victory for New York in three games.

Eagle Owner Forced To Eat 'Humble Pie'

By RALPH HEINSTEIN
Associated Press Sports Writer

PHILADELPHIA (AP) — New York Giants quarterback Norm Snead, with a big assist from running back Ron Johnson, made the Philadelphia Eagles and their owner, Leonard Tose, eat humble pie Monday night. It was in doing his thing on national television (ABC). His thing was 12 of 19 pass completions for 164 yards and three touchdowns. He led the Giants to a 17-12 victory over the winless Eagles.

Johnston, the 205-pound running back who sat out most of last season's season with an injured knee, caused all three of Snead's TD passes, and ran the ball 36 times for 123 yards and the fourth touchdown. It was the first victory for New York in three games.

Johnston, the 205-pound running back who sat out most of last season's season with an injured knee, caused all three of Snead's TD passes, and ran the ball 36 times for 123 yards and the fourth touchdown. It was the first victory for New York in three games.

Johnston, the 205-pound running back who sat out most of last season's season with an injured knee, caused all three of Snead's TD passes, and ran the ball 36 times for 123 yards and the fourth touchdown. It was the first victory for New York in three games.

Johnston, the 205-pound running back who sat out most of last season's season with an injured knee, caused all three of Snead's TD passes, and ran the ball 36 times for 123 yards and the fourth touchdown. It was the first victory for New York in three games.

Major League Standings

By The Associated Press

American League				National League			
Team	W.	L.	Pct.	Team	W.	L.	Pct.
Detroit	85	69	.552	Pittsburgh	95	58	.621
Boston	84	69	.549	Chicago	85	68	.556
Baltimore	79	73	.520	New York	80	73	.523
New York	79	74	.516	St. Louis	74	80	.481
Cleveland	71	83	.461	Philadelphia	70	83	.452
Milwaukee	63	89	.412	Philadelphia	57	97	.370
Oakland	52	61	.461	Cincinnati	53	89	.371
Chicago	46	66	.410	Houston	44	87	.336
Minnesota	38	78	.329	Los Angeles	43	70	.382
Kansas City	35	77	.313	Atlanta	30	82	.267
California	34	79	.302	San Francisco	27	86	.243
Texas	33	89	.268	San Diego	26	83	.241

Psychology Role Big With Shula

By JOHN R. SKINNER
Associated Press Sports Writer

MIAMI, Fla. (AP) — Don Shula might not go along with the "win one for the Gipper" approach of famed Notre Dame Coach Knute Rockne, but he does believe psychology plays a big role in the success of his Miami Dolphins.

"The thing I try to do each week is to point out to them what the situation is," said Shula, boss of the National Football League's lone unbeaten team after three weeks of play.

"We're happy being 3-0," said Shula Monday. "We certainly don't feel we're dominating. I'd hate to think we'll ever start to believe we could win without going all-out," he added.

"My whole philosophy is to worry about our football team — our execution and the way we do things," Shula continued. "The thing you always have to guard against is not playing your best."

The Jets were shocked 26-20 by Houston Sunday after the Dolphins rolled over the Oilers 34-13.

Now Remodeled BOB'S BARBER STYLING

Sanford Plaza 322-9642 for appointment

FENCE

GOOD CREDIT, BAD CREDIT NO CREDIT IS GOOD!

Phone 831-1525

ORLANDO 292-5631 DAYTONA 742-3369

AMERICAN STEEL



FOOTBALL CONTEST

CONTEST RULES

15 football games this weekend are placed, one in each ad on this page. Indicate winner by writing in the name of team opposite the advertiser's name on the Entry Blank. No scores. Just pick winners.

Pick a number you think will be the highest number of points scored in any one game on this page and place this number in the space provided in Entry Blank. This will be used to break ties.

One entry blank only to each contestant. Entries must be brought to the office of this paper or post-marked no later than Friday Noon, October 6.

OFFICIAL ENTRY BLANK

(Reasonable Facsimile Also Accepted)

My name is	Address
H.I.S. store for men	Winner
United State Bank	Winner
Burger In	Winner
Harry's Bar	Winner
Zales	Winner
Florida State Bank	Winner
Knights' Shoes	Winner
Dekle's Gulf Service	Winner
Penney's	Winner
The Sports Shop	Winner
McKibbin Agency	Winner
Vote	Winner
Sanford Herald	Winner
Don't Litter	Winner
Arron's Amoco	Winner

—1ST PRIZE—\$10—

C. A. Miller

122 Hays Dr., Sanford

—2ND PRIZE—\$4—

W. W. Richards

2503 Myrtle Ave., Sanford

—3RD PRIZE—\$4—

Kay Quarett

715 S. Cortez, Winter Springs

NOTHING TO BUY—NO OBLIGATION

THIS CONTEST PAGE WILL APPEAR EACH WEEK DURING THE FOOTBALL SEASON!

CASH PRIZES

TO BE ANNOUNCED EACH WEEK

First Prize \$10
Second Prize ... \$6
Third Prize \$4

MAIL or BRING ENTRY TO: Contest Editor c/o Sanford Herald 300 N. French Ave. Sanford, Fla.

Mary Ann Courier, James E. Alford Exchange Vows In Church Ceremony

By LIZ MATHIEUX
Miss Mary Ann Courier and James Edward Alford were united in Holy Matrimony, Aug. 27, 1972, at the First United Methodist Church of Oviedo with the Reverend A. Bradford Dismore, officiating.

Mrs. Hugh Wallace presided at the console of the organ and presented appropriate wedding airs of the bride's selection. She later accompanied Merritt Staley, soloist, who sang "Because" and "The Lord's Prayer." The love theme from Romeo and Juliet was played softly during the ceremony.

The bride is the daughter of Mrs. Dorothy Courier and the late John E. Courier Jr. The groom's parents are Mr. and Mrs. James H. Alford of Miami. Twin floor standards of brass containing long cathedral tapers which were interspersed in a pyramid arrangement of the pink and white chrysanthemums, stock, carnations and evergreens flanked the chancel of the church.

The three-branched candle service was observed and the family pews were designated by large white satin bows and evergreens.

The lovely bride chose for her wedding vows a formal floor-length gown of white peau-de-soie which featured an Empire bodice. The neckline was outlined in seed pearls and a scalloped chantly lace edging. The voluminous bishop style sleeves were accented by deep cuffs of lace and pearls as was the entire skirt. A wide lace insertion of pearls and lace complemented the gown from the waistline to the back. A flat bow beneath the bodice of the gown served to accent the bride's small waistline.

A full floor-length matilla of imported bridal illusion outlined with a wide border of lace completed her chosen attire. Her bouquet was created of miniature white carnations and pink sweetheart roses and centered with a removable pink rose bud corsage.

The radiant bride was escorted to the altar by her brother, John E. Courier III.



MRS. JAMES EDWARD ALFORD

The attendants gowns were floor-length and were created of pink silk Jakarta. The Empire bodice was outlined with a matching Venice lace. Short sleeves with insertions of Venice lace and a flat Dior bow. A detachable fly-away back panel with insertions of the Venice lace completed the gowns.

Their headpieces were created of large fluffy pink bows from which multi tiers of pink bridal illusion flowed. All completed the attendants' attire. Her bouquet was created of miniature white carnations and pink sweetheart roses and centered with a removable pink rose bud corsage.

The bride's mother chose a most becoming street-length dress of Jakarta in Emerald green which featured a jeweled neckline. Her accessories were matching and she wore a cymbidium orchid corsage.

The bridegroom's mother wore a peacock blue street-length dress of chiffon with a lavish ruffle trim. Her accessories were matching and she also wore a cymbidium corsage.

Mrs. John E. Courier Sr., paternal grandmother of the bride, wore a street-length dress of pink polyester with a richly embroidered trim. Her accessories were white and she wore an orchid corsage.

Immediately following the wedding the church fellowship hall was the reception site.

Mrs. William Crona, Orlando, presided at the bride's book table which was overlaid with a dainty lace cloth and centered with a cupid epergne which was filled with pink sweetheart roses.

The bride's cake table was overlaid with a white linen cloth with an oversize of white lace. The wide satin ribbon border edged the cloth.

The traditional white bridal tiered cake was served. Mrs. J. M. Staley and Mrs. J. M. Gore cut and served the cake and Mrs. Jimmy Holder and Mrs. Robert Graham poured punch. Nuts and mints were served and all sterling silver and crystal table appointments were used.

Hostesses at the reception were Mrs. James Partin, Mrs. James Palmer, Mrs. Charles Brown, Mrs. Paul Stapp, Mrs. Leon Gillis, Mrs. Joe Beasley, Mrs. Ben Wainwright, Mrs. Ben F. Ward Jr. and Mrs. Paul Stapp.

For traveling to their destination in North Carolina Mrs. Alford chose a becoming green polyester dress with a matching coat. Her accessories were beige and she wore the pink sweetheart rose corsage from her bridal bouquet.

They are presently residing in Oviedo where Mrs. Alford will be a student at Florida Tech University and will be working part time at Florida State Bank. Mr. Alford is employed at FTU.

Guests from out-of-town came from Miami, Jacksonville and Palmetto.



BRIDE-ELECT ELAINE OWENS, left, was guest of honor at a pre-nuptial luncheon Saturday at the home of L. Col. (ret) and Mrs. Harry Wayne Smith. Captured with the honoree are, from left, Mrs. H. B. Owens, her mother; Mrs. W. B. RICHARDE, mother of the future bridegroom; and Mrs. Smith and daughter, Mrs. Thomas Barks, hostesses.

Miss Elaine Owens Honored At Pre-Nuptial Luncheon

By DORIS WILLIAMS
Society Editor

All eyes were focused on pretty Elaine Owens at a pre-nuptial luncheon given in her honor Saturday.

Hostesses were Mrs. Harry Wayne (Dorothy) Smith and her daughter, Mrs. Thomas (Claudia) Barks who entertained at the Smith home in Loch Arbor.

Elaine was positively glowing in a long-sleeved long gown fashioned along the Empire silhouette of purple and burgundy tones in a woven knit pattern.

They are presently residing in Oviedo where Mrs. Alford will be a student at Florida Tech University and will be working part time at Florida State Bank. Mr. Alford is employed at FTU.

Guests from out-of-town came from Miami, Jacksonville and Palmetto.

gown was a white carnation corsage, a gift from the hostesses.

The bride-elect's mother, Mrs. H. B. Owens, wore a floor-length carise gown with lace enhancing the front panel. Mrs. W. B. RICHARDE, mother of the future bridegroom, Michael RICHARDE, chose a long red, white and white print gown. Both mothers received colorful corsages from the hostesses to match their gowns.

The relaxed hostesses also captured the long look in their modes. Dorothy wore a brown and white print skirt with a long-sleeved cocoa knit top.

Elaine was presented a gift of crystal in her registered pattern from the hostesses. The oval-shaped dining room table, which was covered with an all-white cloth edged in wide lace, was centered with a perfectly beautiful silver epergne arrangement of tall white tapers, pink and white carnations, Eucalyptus, and baby's breath and topped with two white love birds.

The bride's colors of pink and white were further carried out in individual tables, covered with white linen, and centered with a single silver candlestick holding a white candy and carnations and greenery.

The hostesses served delicious salad lunches complete with tomato juice cocktail, heavenly hot rolls, tea and coffee and an ice dessert.

Others enjoying the hospitality and delight of the luncheon were Mrs. S. RICHARDE Sr., the bridegroom's grandmother who also received a corsage from the hostesses, Mrs. John Y. Mercer, Mrs. Cecil Carlton and Mrs. E. B. Owens.

Also Mrs. Tom Gamble, Mrs. Walter Cook, Mrs. J. D. Dinning, Mrs. Sarah Hendry, Mrs. Debbie RICHARDE, Miss Catherine, Mrs. S. M. RICHARDE Jr., Mrs. C. E. Flettemeyer and this special.

FTU Schedules Formal Rush Week

A national institution is about to get underway once again at Florida Tech University, where a campus-wide formal rush by four sororities is scheduled to start Oct. 8 with the traditional "ice water teas" that have long marked this bit of college life.

FTU has come a long way with its sorority programs since October, 1968, when classes began on the sprawling campus. This fall, for example, there are nearly twice as many women enrolled in sorority organizations as in 1968.

Small but strong would be an apt description of the four sororities at FTU. With some assistance from a variety of quarters, foremost from Dean Carol Wilson, the groups aim to increase their ranks during Rush. By so doing, they also will be able to add to the list of community service activities each and all have become involved in over the past several years.

The four groups at FTU — Delta Delta Delta, Zeta Tau Alpha, Alpha Chi Omega, and Tyes — have some identical objectives, but each also is out to what interest in its particular philosophy during Rush registration, which extends through Oct. 6. Women who sign up during this period receive invitations to the ice water teas.

As noted by Dean Wilson, the primary purpose of rushing is to provide answers to questions such as, "what does a sorority offer?" "How can it benefit me?" and "How can I benefit a sorority?"

The final step is the most difficult, admittedly. It's known as bidding, and that means, simply, that the groups extend invitations to those young women the sororities want to join their ranks. At this point the women receiving invitations either do or do not accept.

The basis for selection by a sorority is hinged upon a number of tangibles and intangibles. There's scholarship and the desire to become involved, and there's compatibility and enthusiasm, to name a few.

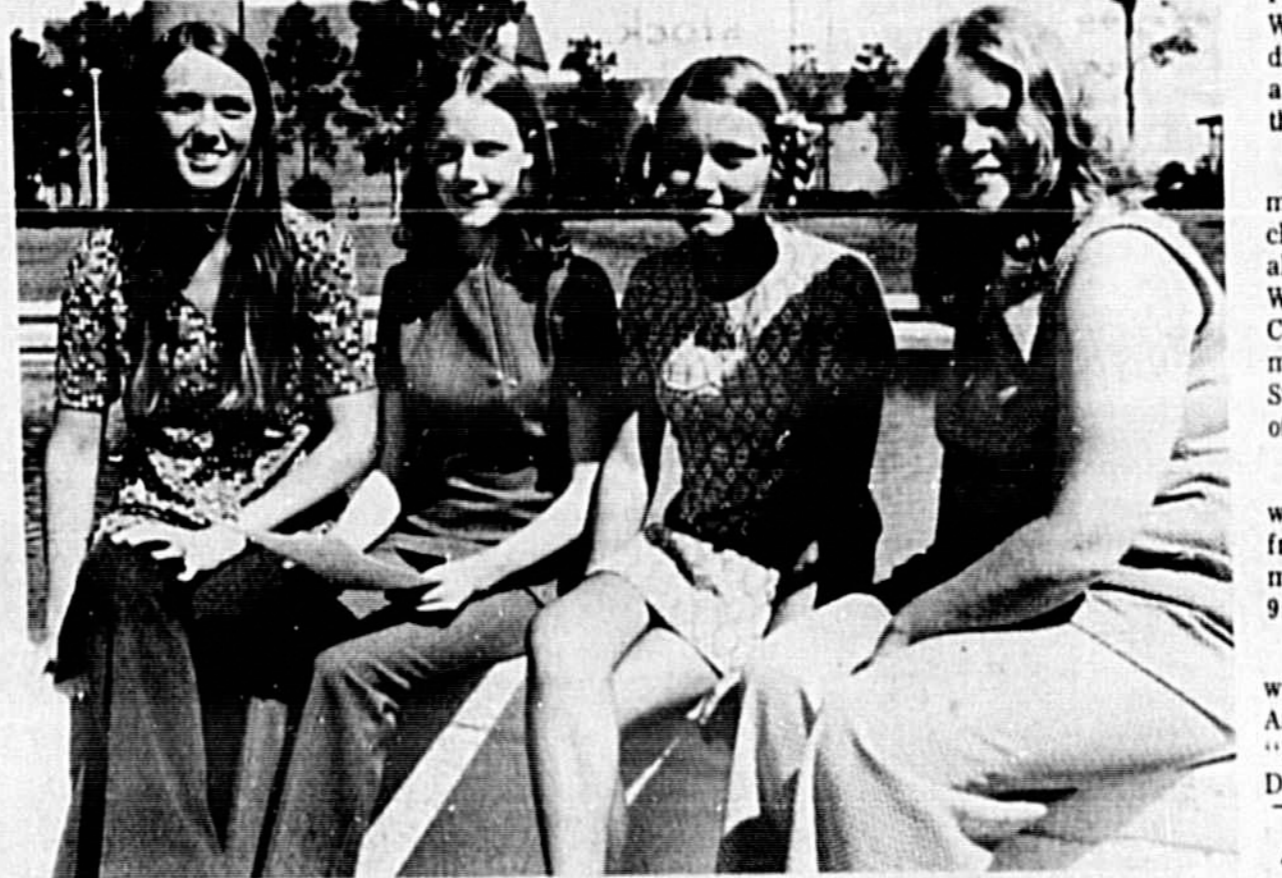

FOUR MAIDS IN A ROW — Planning for the annual sorority Rush Week on the Florida Tech University campus are, from left, Diane Nixon, a Tri Delta and chairman of the FTU Panhellenic Council; Marsha Hall, Zeta Tau Alpha; Susan Trapp, Tyes; and Janet Vickers, Alpha Chi Omega. (FTU Photo by Richard Spencer)

by others who added the friendships and extracurricular activity that go with sorority life are major contributing factors, too.

No small matter, either, is the academic side of sorority life. "We strive to help each other any time we can," said Diane Nixon, chairman of Panhellenic Council. Part of the initiative is provided by the Council through trophies for scholarship, service and in-student awards. Sorority membership provides the opportunity for making college

more than a "classroom and highway" experience. Some of the community-service activities in which FTU sororities have played a major role over the past year shape up like this: a two-day fund drive for the Florida Symphony Orchestra that collected more than \$3,000 and put the drive over the top; a 20-mile hike for the March of Dimes; children visits to "adopted" children at St. Luke's Home in Slavia; working as runners and tabulators during the annual Central Florida Cerebral Palsy

telethon; visits to Sumter Correctional Institution for dinner with inmates; and working with juveniles and their families through County agencies. And those are only a part of the whole picture. The sororities also keep a hand in countless campus activities, from cataloging records and tapes for the campus radio station (WFTU) to serving as tour guides, as aides during orientation weeks and with volunteer cleanup crews doing their thing for ecology.

Little Miss BPW Deadline Extended 'Sky King' To Emcee Contest

Have you entered your three, four or five-year-old little girl in the LITTLE MISS BPW CONTEST yet? The contest is running out! Deadline for entries must be in by Monday, Oct. 16.

This contest is being presented by the SANFORD BUSINESS & PROFESSIONAL WOMEN'S CLUB to help raise funds for the relocation and renovation of the SANFORD ZOO.

Entry forms are available from various merchants in the area, so pick yours up today and send it in. Please remember to attach a recent photo of your child so it can be put on display in the lobby of the Sanford Atlantic National Bank for everyone to see.

Three winners will be chosen by judges Cliff Nelson (Seminar Zoological Society), Mrs. Walter Glew (Sanford Herald) and Bill Reek (WTRR).

Kirby Grant, SKY KING, will officiate as master of ceremonies and another special celebrity guest will also be in attendance.

100% Polyester Knit
Slacks
Reg. \$17 - \$18 - \$19 - \$20
995
This week or while they last.

HIS Store for Men
SANFORD PLAZA
Colgate vs. Yale

Enjoy your personalized **Class Ring Now!**
\$5 down!
GIRLS' sizes \$46
BOYS' sizes \$56
Open a student account!

SALES
Sanford Plaza
Columbia vs. Princeton

Bowling Balls 1999
Personal 300 black rubber bowling ball. Made expressly for JCPenney by Ebonite. Endorsed by Don Carter. Meets or exceeds all American Bowling Congress specifications. Hard rubber is scratch and dust resistant. Has specific top weights—a pro feature design—for better control. In 10, 12, 14, and 16 lb. weight.
2299
Personal 300 plastic bowling ball. In four exciting colors: ocean blue, sierra green, desert tan or wild plum. Made by Ebonite for Penneys and endorsed by Don Carter. Meets or exceeds all American Bowling Congress specifications. In 10, 12, 14, or 16 lb. weight. Also available in our newest red, white and blue color combination.

JCPenney
The values are here every day.
SANFORD PLAZA 10-9 MON-SAT.
Pennsylvania vs. Brown

Complete line of **ITHACA** shotguns and rifles... now in stock.
Get ready for hunting season!
The Sports Shop
OPEN ALL DAY WEDNESDAYS
SANFORD PLAZA
Indiana vs. Syracuse

the 1972-73 **Seminole High Boosters Club**
\$1 or more.
UNITED STATE BANK
of Seminole... SANFORD PLAZA
A FULL SERVICE BANK MEMBERSHIP D.I.C.
Iowa vs. Purdue

TRADING HOME CARS IMPROVEMENT
Bank Financing
COSTS YOU LESS!
FLORIDA STATE BANK
We can handle all your banking needs.
Kansas St. vs. Colorado

HARRY'S BAR and PACKAGE
The place to meet your friends... and RELAX
114 S. PARK AVE. 322-9860
Cut Rate Liquors Special Case Prices
YOUR BANKAMERICARD WELCOME HERE!
Minnesota vs. Kansas

See you after the game!
WHERE THE ACTION IS!
GNASH INTO A "SUPER"
NO BETTER BURGER ANYWHERE
NEW! AIR CONDITIONED DINING ROOM!
Burger In
2109 FRENCH SANFORD
Northwestern vs. Wisconsin

Freeman Soft
in brown or black calf.
2999
Knight's
208 E. FIRST ST. 322-0204
Auburn vs. Mississippi

DEKLE'S GULF SERVICE
OPEN 24 HOURS DAILY
Watch television in our air conditioned waiting room while we service your car.
GULF PRODUCTS
• Tires • Batteries • Accessories
Experienced Mechanics Expert Wash, Polish and Wax Jobs.
KING TRUCK—ALL NEW CAR RENTALS
TWO LOCATIONS
2518 S. French 322-4924
Sanford Airport 322-4821
Florida vs. Fla. State

INSURE WITH CONFIDENCE
114 NORTH PARK AVENUE - P. O. DRAWER A
SANFORD, FLORIDA 32701
322-0331
Ga. Tech vs. Clemson

Help Guide America's Future
VOTE Oct. 3
Louisville vs. Tampa

Keep Florida Beautiful
DON'T LITTER
Read
831-9993
322-2611
Maryland vs. Wake Forest

GOODYEAR
ALL WEATHER
IV
650-13
Sat Of 4
\$49.20
AARON'S AMOCO
"Where Service is the Best"
2397 French Ave., Sanford
Ph. 322-9621
West Virginia vs. Wm. & Mary

SEND FLOWERS
SANFORD FLOWER SHOP
209 Commercial Ave. 322-8432

LIFE STRIDE'S LOOKING BETTY
BLACK SUEDE SORCERY
Put a little black magic at your feet in the beauty of black suede. With its plush look and velvety feel, it'll turn your next evening out into a spellbinding occasion.
Black & Carmel Suede
Sizes 5 to 10 AAAA to B Widths
Life Stride SEUCES
MATCHING HANDBAGS
\$1899
228 E. First St.
Dial 322-3524
BANKAMERICARD MASTER CHARGE

SPECIAL PIANO \$12 RENTALS \$12 MONTHLY WITH PVT. LESSON.
CANNON MUSIC CO.
1601 S. Columbia Ave., Tallahassee 904-7600
1244 E. Columbia St., Orlando 445-3708

GARY'S BOOKS
ARTISTS SUPPLIES PLASTIC MODELS
PAINT BRUSHES GIFT BOOKS, BIBLES
PAPER PADS PAPERBACKS CHILDREN'S BOOKS
PASTELS, ACRYLICS CHILDREN'S BOOKS
MIMEOGRAPHING & DUPLICATING SERVICE
714 W. 1st St. Sanford, Fla.
OPEN 12 NOON TIL 9 P.M.
(Between Tres Chic & Garfield's Barber Shop)

Area Vocalists Invited To Audition
The Opera Gals Guild of the Florida Symphony Society would like to extend an invitation to all area vocalists to participate in the auditions for their next production, La Boheme (Feb. 2 and 4, 1973) and La Rondine (March 23 and 25, 1973).
Openings are available for both male and female singers. The auditions will be held on Saturday, Oct. 7, at 3 p.m., at the Municipal Auditorium, 401 West Livingston Ave., Orlando. Any soprano wishing to audition for the All-Gerswund Concert on the Promenade Series should come prepared to sing "Summertime" from Porgy and Bess.
Regarding these auditions, contact Robert L. Landers, P.O. Box 782 Orlando, 32802, Telephone, (305) 941-1380 or Mrs. Joyce Parker, 1217 Elinore Drive, Orlando, Telephone, (305) 859-4200.



Lovebirds, keep Johnny out of the house tonight

By Abigail Van Buren

DEAR ABBY: Ralph and I have been married for two years, and we are still very much in love, but here's our problem: Ralph is "scheduling" what used to be our most beautiful and romantic moments, and I don't like it. He says, "No romance until after Johnny Carson."

Abby, sometimes I don't want to stay up that late, but because I have to be up at 6 a. m. sharp every day, but Ralph stays up to watch the whole show no matter who's on.

I think he's being selfish, and he thinks I'm being stubborn. I'd like your opinion. And in case you think this is a gag, I'm signing my full name, but please don't use it.

DEAR GAIL: If your husband isn't turned on until Carson is turned off, you need more help than I can give you in a letter. I'm afraid the honeymoon is over when the boob beside you ignores you for the table.

DEAR ABBY: As a supervisor in a typing pool, I have consistently informed my girls that there is no such word as "reoccur," and the word should be "recur." Now, to my horror, I find that you have used the word "reoccurring" in your column, and since you are an expert, I feel that there must be some basis for using the word, or you wouldn't have printed it in your column.

Please restore my faith in you, and inform your readers where we can find the word "reoccur." It does not appear in my copy of the American College Dictionary. Sincerely, MYRNA IN COLUMBUS

DEAR MYRNA: You will find the word "reoccur" on page 1922 of The New Webster's Third International (bridged) Dictionary. It is between "reoccur" and "reoccurring." I make it a share of reoccurring errors, but this isn't one of them.

DEAR ABBY: I do not drive a car, so I do a lot of walking. My problem is that I have been threatened, frightened, and nearly bitten by dogs. How does one defend himself against dogs without appearing ridiculous?

I can't always carry a cane. Besides I've been told that when a dog sees a cane, he knows it's a weapon, and the carrier practically invites attack.

I know there are laws where I reside, stating that dogs must be on a leash, but nevertheless I see plenty of dogs loose, and worse yet, I see them.

DEAR AFRAID: Will you take a tip from a veteran mail carrier who has picked many a dog with a dog? He says the government provides each mail carrier with a "spray," which is an animal repellent. Also, instead of a cane, carry a leather belt with a big knot in the buckle end, and if a dog attacks you, give it a good clout on the nose with the knot. Also, never turn your back on a dog or run, for he'll surely attack you. Finally, if you are in doubt as to the friendliness, check his tail. If it's stiff-reach for the spray!

FORECAST FOR WEDNESDAY, OCTOBER 4, 1972



GENERAL TENDENCIES: A strange sort of aspect is in effect that makes you want to do things in a manner that others may resent. Yet, this negative subject is not likely to be vital and most repetitions can enter into one's thinking. Stick to proven methods.

ARIES (Mar. 21 to Apr. 19) Although you have a great deal to do, be sure not to disturb others today. Take treatments that will improve your health greatly. Become more active instead of daydreaming.

TAURUS (Apr. 20 to May 20) Make sure that you delight others during spare time and add to circle of friends. You can now be of assistance to others. Engage in things that are not expensive.

GEMINI (May 21 to June 21) See what you can do to make your home more charming and delightful, but pay attention to important details that are in good taste. Enjoy the comforts of home with mate tonight.

MOON CHILDREN (June 22 to July 21) A good day for handling small matters which have accumulated and are very important. Take right means to gain goodwill of others. Don't be so temperamental in the future.

LEO (July 22 to Aug. 21) Plan how to make your home more charming as well as add to its value, and then talk over with expert how to add to present income. Be diplomatic with an important businessman.

VIRGO (Aug. 22 to Sept. 22) You are tempted to engage in something that is risky and which you could regret later, so stick to the tried and true. Instead being careful of your diet is important now.

LIBRA (Sept. 23 to Oct. 22) Make sure to remove a stumbling block to your progress instead of continuing to contend with it as you have in the past. Take the right treatments that will improve your health.

SCORPIO (Oct. 23 to Nov. 21) Accept a social invitation which could lead to fine things in the future via the meeting of important personalities. Use your own good judgment now instead of relying on a friend.

SAGITTARIUS (Nov. 22 to Dec. 21) Show your finest talents to higher-ups and open new doors of opportunity for yourself. Be careful not to talk yourself out of something. Do more listening than talking.

CAPRICORN (Dec. 22 to Jan. 20) Although your new ideas are fine, be sure to study every facet of them or you will not be successful in putting them in operation. You can learn much from new friends.

AQUARIUS (Jan. 21 to Feb. 19) You can do much more than has been hard for you in the past. You may differ with what mate is saying, but don't argue. A petty smooths everything out. Show that you have wisdom.

PISCES (Feb. 20 to Mar. 20) Don't be perturbed by getting even with an ally who has acted thoughtlessly. Show consideration since this person has been having family trouble. Show that you are a sensitive person.

IF YOUR CHILD IS BORN TODAY he or she will be one of those meticulous young people who wants nothing out of place. This is fine, provided the human and religious principles are first taken into consideration, otherwise your progeny will live a lonely life with few friends, and not achieve the fine promise in this chart. Give an opportunity early in life to be with other young children and to learn to be a good sport. Early religious training is a must.

The Stars impel, they do not compel. What you make of your life is largely up to YOU!

Carroll Righter's Individual Forecast for your sign for October is now ready. For your copy send your birthdate and name to Carroll Righter Forecast (Name of newspaper), Box 629, Hollywood, Calif. 90028.

At the Beach

Table with 2 columns: ACROSS and DOWN. Contains crossword puzzle clues.

Grid for crossword puzzle with numbers 1-30.

(NEWSPAPER ENTERPRISE ASSN.)

POLLY'S POINTERS

How To Remove Mattress Odors

By POLLY CRAMER

DEAR POLLY—Mrs. W. M. L. might try my method for removing odors from her mattress. Plain borax works wonders on such odors. Dampen the spot with water and vacuum over it, rub slightly, let dry and then vacuum off. She may have to repeat the process since hers has "set." I used this when my children had accidents and, if applied immediately, no spot was left.—KAREN

DEAR POLLY—Mrs. W. M. L. should try a solution of baking soda and cold water for removing the odor from her mattress. Soak a sponge in the solution, rub mattress well so it is wet but not soggy. This is a good remedy for removing odor from a dress when baby burps milk on your shoulder. I have also used it for perspiration odors in woollens.—MRS. R. W.

Polly's Problem

DEAR POLLY—Is there any way to more or less permanently mark tennis balls so you can identify your own? Ink and marker pens wear off after a game or two and I am unable to find my ball. When four such outfits are made they are handed out to the girls.—J. O.

WIN AT BRIDGE

Bridge hand analysis table with columns for NORTH, WEST, EAST, SOUTH and various card counts.

Discards Are Finesse Clues

Now it is up to South to cash all his top cards in hearts, diamonds and clubs. Maybe the squeeze will develop. It doesn't, but something else does. South watches the fall of the cards. He sees East discard on the second club and fourth heart, and West discard on the third diamond. This gives him a perfect count of the hand. Three hearts, five diamonds, one club and four other cards which have to be spades.

By Oswald & James Jacoby

South can count 11 easy tricks at his slam contract. He also sees that if spades break or the jack drops he has his 12th trick right there. If he is a really good player he will note that there is a 2-0-8-3-1-1 club-spade squeeze but that should give up a trick to establish the squeeze situation. The only place to give up a trick is in clubs so South wins the heart lead in dummy and leads a club to his jack.

Highlights TV Time Previews

TUESDAY, OCT. 3, 1972

8-8:30 CBS, Maude, "Like Mother, Like Daughter." This is a very funny story. Maude was jilted about 10 years ago, before she met and married Walter. Daughter Carol starts dating an older man. Guess who? The guy who jilted Maude, Maude launches a get-out-of-my-house campaign and even attempts to discourage him to hurt Walter's pride by showing she still feels rejection.

Television

Television schedule table with columns for TUESDAY, WEDNESDAY, THURSDAY, FRIDAY, SATURDAY, SUNDAY.

Albert Is 51st Prexy For Kiwanis

When newly installed Sanford Kiwanis Albert rangs the Kiwanis bell at the Wednesday luncheon meeting at the Sanford Civic Center he will be the 51st President of the Kiwanis Club since 1922 when Albert P. Connelly called the first meeting to order, an uninterupted roster of illustrious Sanfordites have presided over Sanford's largest and oldest service organization.

The administrative theme for the year 1972-73 set by Kiwanis International is SHARE YOUR LIFE.

Wednesday Night is Family Night

Regular \$1.25 Dinner Free Drink (As \$1.42 Value) NOW ONLY \$1.10 Good 4:30 til 9 p.m.

Advertisement for Famous Recipe Fried Chicken, featuring a picture of a chicken and promotional text.

Advertisement for Alfred Hitchcock's 'Frenzy' at Plaza Theatre, featuring a picture of the movie poster.

Advertisement for The Queenman Game at Regis Theatre, featuring a picture of a horse and rider.

Advertisement for Melinda at Regis Theatre, featuring a picture of a woman's face.

Advertisement for Bahama Joe's Seafood House, featuring a picture of a seafood dish and promotional text.

Advertisement for Wednesday Night is Family Night, featuring a picture of a chicken and promotional text.

HOLLYWOOD HOTLINE

Guests a problem for 'Laugh-In' By NANCY ANDERSON. Friends for comedians on the show, but now the situation is reversed, sometimes embarrassingly so.

BETTY CANARY 20 Years Hence. It Won't Matter. One fine day I gave up trying to be organized. Until then I had tried to live according to plan and schedule.

WORRY CLINIC By George W. Crane, Ph.D., M.D. Mildred's complaint about TV programs is all too true. Tired viewers don't want to use their imaginations to evolve solutions.

Bahia Temple Shrine Circus. Produced by William Kay. Tinker Field - Orlando. FRI. 6TH SAT. 7TH SUN. 8TH OCT. 6 OCT. 7 OCT. 8 SHOW TIMES: FRI. 4:00 PM & 8:00 PM SAT. 1:00 AM - 2:00 PM SUN. 10:00 AM & 5:00 PM

Advertisement for Bahia Temple Shrine Circus, featuring a picture of a circus tent and promotional text.

Advertisement for Photos, featuring a picture of a woman's face and promotional text.

Comic strip 'Alley Oop' by V. T. Hamlin, featuring a cavewoman character.

Comic strip 'Campus Clatter with Bimo Burns' by Larry Lewis, featuring a student character.

Comic strip 'Priscilla's Pop' by Al Vermeer, featuring a girl character.

Comic strip 'The Badge Guys' by Bowen & Schwarz, featuring police characters.

Comic strip 'Captain Easy' by Crooks & Lawrence, featuring a detective character.

Comic strip 'Sgt. Stripes... Forever' by Bill Howrille, featuring a soldier character.

Comic strip 'Bahia Temple Shrine Circus' by William Kay, featuring a circus scene.

Comic strip 'Winthrop' by Dick Cavalli, featuring a character in a suit.

Comic strip 'Blondie' by Chic Young, featuring a blonde character.

Comic strip 'Beetle Bailey' by Mort Walker, featuring a character in a military uniform.

Emergency Medical Care

'Weakest Link' Is Cited

By G. DAVID WALLACE
Associated Press Writer
WASHINGTON (AP) — Doctors were alarmed when they saw the burned and battered 17-year-old youth wheeled into the hospital emergency room.
On a bed he had climbed a utility pole in rural Georgia. The electrical jolt at the top burned his shirt off. The 30-foot fall broke his back and some ribs. One lung was punctured.
But the doctors' alarm multiplied when the ambulance driver boasted how he himself had handled the emergency. He dragged the youth 50 yards to

the ambulance, then rushed to the hospital without immobilizing the victim on a back board to spare possible aggravation from broken bones grinding and cutting through the youth's body.
The youth was relatively fortunate. He lost an arm to the electrical burn, but his other injuries mended without crippling damage.
But another 60,000 persons were not so fortunate last year. That's the number of heart attacks, accidents and other victims of sudden illness who could have lived if given proper emergency care, according to

the Department of Health, Education and Welfare.
"Emergency medical service is one of the weakest links in the delivery of health care in our nation," said the National Academy of Sciences in a March study.
The conclusion is echoed repeatedly in government reports and testimony before Congress.
The academy estimated more than 30,000 of the 25,000 ambulances in the country are of the horse, limousine or station wagon type "inadequate in space and equipment." The Department of Transportation



RE-ELECT
AL DAVIS
County Commissioner
District 3
Dem.
pol. ad. pd. for by Al Davis

Scribe Recounts Meeting With 7 American POWs

By PETER ARNETT
AP Special Correspondent
Seven men. All dressed in simple blue denim prison garb. All covered. All American. And they had something else in common: a powerful desire to come home.
I could reach out across the table and touch their hands. Yet the gulf between us was immeasurable. I was a free man, about to board a plane within the hour and wing back to the United States.
Not these men. One of them, Navy Cmdr. Eugene Wilbur, from Columbia Cross Roads, Pa., had sat across that table a dozen times in the past four and one half years, watching faces of free men flit by as he waited for his turn.
Wilbur and the six others

were all U.S. pilots shot down over North Vietnam and held in prisoner of war camps. I was escorted by a delegation of four American antiwar activists in Hanoi to escort home three pilots released by the North Vietnamese.
At the last moment of our ten-day visit we were summoned to a Government building in downtown Hanoi. We were ushered into a long room and saw tables crowded with beer bottles and glasses.
A few seconds later they came in, seven men with hands outstretched and faces beaming. They were more eager to see us than any other men I had ever met.
Two North Vietnamese officials sat in the room with us. Reporters and television cam-

FREIGHT DAMAGED FURNITURE
OR
1/2 OFF MORE
NOLL'S FURNITURE SALES
CASSELBERRY
HWY. 17-92

At Town & Country... IT'S A WHOLE NEW

BALLGAME

New Facility Plus New '73 Model Trade - Ins Adds Up To Better & Fresher New Cars - Sure To Score Big With You, Our Customers

SPECIAL OF THE WEEK
1970 Mercury Marauder
Fast Back, Loaded! Light grey finish with distinctive black vinyl roof. Priced to really Please!

CATCH A BARGAIN
1970 Mercury Monterey 9 Passenger Wagon
A one owner like new with less than 30,000 miles and loaded with equipment including luggage rack. Extended drive train warranty available.
\$2795

1969 MARK III
Featuring all Continental luxury options, finished in silver with white top and white leather interior.
\$3895

1971 VW Square Back
Station Wagon equipped with factory air conditioning, automatic transmission, luggage rack and radial tires. Ready to move out at a low price.
\$1895

1969 Mercury
Monterey 4 door loaded with equipment, beautiful red with white top. Good transportation at a budget price.
\$1095

1967 Mercury
Colony Park 9 Passenger Wagon loaded with equipment and Super Priced At—
\$895

1971 Mercury
Monterey 4 door loaded with equipment and finished in light green with green vinyl interior. A real nice car for only—
\$2295

1970 Mercury
Marquis 4 door, fully equipped including power windows and power seats also AM-FM stereo.
\$1995

1969 Lincoln
Continental 4 door sedan featuring every Lincoln luxury option and reasonably priced at—
\$2395

1970 Maverick
2 door equipped with automatic transmission, big 6 cylinder engine and radio. Truly an economy car.
\$995

Town & Country
LINCOLN MERCURY
5. HWY. 17-92 at 5 POINTS Ph. 322-4884 - 831-8090



TEAM TEACHERS with the county gifted child program, Karen Stratton (left) and Shirley Stuart, instruct Longwood Elementary School fourth level student Michelle Sheffield on the use of a microscope. (Ann Riley Photo)

Laser Replaces Scapel

SAN FRANCISCO (AP) — An invisible laser beam that cuts more sharply than any scalpel has been used successfully to remove dead skin from burn victims and repair damaged internal organs in animals, medical researchers report.
Dr. James P. Fidler, director of the University of Cincinnati Medical Center's laser laboratory,

discussed his research team's new surgical laser at the opening of the College of Surgeons 50th annual clinical congress here Monday.
Fidler said the technique uses an electric arc to excite molecules of carbon dioxide gas until they send out a beam of intense, highly focused, and coherent radiation.

When aimed at tissue through a microscope, this laser beam's bursts of invisible light produces a spot of heat less than a hundredth of an inch deep, enabling it to cut more precisely than any scalpel, Fidler said.
He said experiments on animals give hope the laser will be useful in surgery.

He said experiments on animals give hope the laser will be useful in surgery.

He said experiments on animals give hope the laser will be useful in surgery.

He said experiments on animals give hope the laser will be useful in surgery.

He said experiments on animals give hope the laser will be useful in surgery.

He said experiments on animals give hope the laser will be useful in surgery.

He said experiments on animals give hope the laser will be useful in surgery.

He said experiments on animals give hope the laser will be useful in surgery.

He said experiments on animals give hope the laser will be useful in surgery.

He said experiments on animals give hope the laser will be useful in surgery.

He said experiments on animals give hope the laser will be useful in surgery.

He said experiments on animals give hope the laser will be useful in surgery.

HERALD BUSINESS REVIEW
For Your Story And Picture Call 322-2611 or 831-9993

For Fast Dependable Service
Put Your Car . . . In Our Hands!
Experienced Mechanics
Wash, Wax & Polish Jobs
Tires - Batteries - Accessories
RING CAR TRUCK WAITING ROOM RENTALS WITH TV
DEKLE'S GULF SERVICE
2518 S. French Ave. Ph. 322-4924

ANTIQUES BOUGHT & SOLD
ANTIQUES REFINISHING FURNITURE OPEN 7 DAYS A WEEK
HENDRIX'S ANTIQUES
2 MI. No. of Oviedo On Hwy. 419
Ph. 365-3740 Home 365-5144

WE STOCK IMPORT AND SPEED PARTS
• Engine Rebuilding
• Complete Valve Work
• Engine Rebuilding
• Head & Block Resurfacing

OPEN SUNDAY
9 a.m. - 2 p.m. DAILY 8 a.m. - 6 p.m.
MIXON AUTO PARTS AND MACHINE SHOP
Phone 322-8808
222 Magnolia Sanfo

Wise Guys
Advertise In The SANFORD HERALD
"If Your Would Like To Advertise Your Business On This Page And Picture -"
"CALL JAN"
322-2611 or 831-9993

ADAMS AUTO PARTS
Full Line New & Rebuilt
Refrigerant Parts
Oil, Additives & Supplies
Machine Shop
IGNITION SWIRLS
EXHAUST SYSTEMS
AIR CONDITIONING PARTS
DREAM & BUCK PARTS
CHASSIS
CARBURETORS
2553 Park Dr. (Corner of Park & Elm) Sanford One Block East of 17-92

CALL or DROP BY AND ASK **John Dickey** ABOUT THE NEW
STEEL RADIAL BRIDGESTONE TIRES
The revolutionary tire designed for long distance and freeway driving.
GUARANTEED for 40,000 Miles ALL SIZES AVAILABLE
McROBERTS TIRES
JOHN DICKEY INC.
405 W. First Sanford 322-0651

Jewel And Yvonne
New Beauty Salon Opens

By ANN SIECZKOWSKI
Whatever the time of day, the woman who stands out in any crowd, then why not start at the top of the ladder - with your hair. The best place for that expert treatment is at the salon of Jewel and Yvonne, located at 2012 French Avenue just across the street from Sun Travel Agency.



Jewel Goolsby and Yvonne McCollough have opened a brand new beauty salon - only two weeks ago and they are open from 8 a.m. to 5 p.m. on Tuesdays, Wednesdays, Thursdays and Fridays. On Thursday, they stay open late for the convenience of their clients. And on Saturday they are open until 2:30 p.m. Earlier or later hours are available by appointment.
These gals can do marvelous things with your hair - whether you wish the chic and short, smooth, sophisticated, or very high style - you will find that what ever your mood or need at the moment, Jewel or Yvonne can arrange your hair for the occasion.

The charm of some of the classic designs combines with the details of today to produce a lovely silhouette with face framing softness and graceful wave flattering patterns.
And if you want to change your hair color, try Jewel and Yvonne. Beauty through illusion comes with the hair-stylist's artistry in coloring - relating frosting placement to your facial structure. These beauticians can use hair color as effectively as the right haircut or style line to accentuate your beauty.
For your smart swingers who wear your hair a little longer than short, let Jewel or Yvonne set in flowing waves ending in a glorious flare of curls - just bound to inspire backward glances as you go down the street.
They can dress your hair in styles which will carry you quite appropriately from day into evening. At Jewel's and Yvonne's shop, they have a wonderful show of styles - waves and swirls of pretty styles which curve around your head creating halos of loveliness.
Of course, in today's busy world, it is good to have a wig wardrobe or at least one for that time when you need a pickup and it is not time for your regular appointment with Jewel Or Yvonne.
They can custom order your wig for you and then they can

today's FUNNY
INDIANS WERE HERE FIRST BECAUSE THEY HAD RESERVATIONS
© 1972 BY NEA, INC.
There's Love Here, Kenna

BLAIR AGENCY
Cor. 3rd & Park Ave. Sanford
AUTO INSURANCE
CANCELLED REJECTED DECLINED
SR22'S FILED
Welcome Senior Citizens Young Drivers
for Quote's PHONE 323-3866

ADAMS AUTO PARTS
Full Line New & Rebuilt
Refrigerant Parts
Oil, Additives & Supplies
Machine Shop
IGNITION SWIRLS
EXHAUST SYSTEMS
AIR CONDITIONING PARTS
DREAM & BUCK PARTS
CHASSIS
CARBURETORS
2553 Park Dr. (Corner of Park & Elm) Sanford One Block East of 17-92

Yes . . . You Can Get Results!
For More Information CALL **322-2611 or 831-9993**
Ask For Jan Torbett Your Advertising Consultant
Don't Put Off 'Til Tomorrow What You Can Do Today

Let Us **BLOW YOUR WHISTLE!**
Our Toot Is Loud And Strong
ADVERTISE
Your Business or Products in the Business Review Section of The Herald
Let us feature Your Business with a **PICTURE and STORY**
Your Ad On These Pages Will Acquire 100,000 Prospects With Your Product Or Service

ABC LIQUOR SALE AMERICA'S LARGEST WINE & SPIRITS DEALER SAVE 40% VISIT YOUR BEAUTIFUL NEW SWINGING ABC COCKTAIL LOUNGE	SOUTHERN COMFORT 100 PR. VODKA SCOTCH COMFORT ABC CANADIAN ABC 8 YEAR 4.99 STB	QUEEN ANNE MYER'S RUM "RARE OLD" BEEFEATER 5.29 STB
HARWOOD IMP. CANADIAN LEILANI MR. ED. KY. ST. BOURBON SCOTCH LIQUOR IMP. SCOTCH 3.99 STB	GALLIANO 81% B & B 7.75 STREGA 7.50 MARIE BRIZARD 2.99	TV VODKA LEWIS "66" 90 PR. GIN ROYAL DELUXE GLENMORE 4.75
WINDSOR IMP. CANADIAN SCHENLEY OLD WHISKY HEAVEN HILL 3.99 STB	BOND'S HILL ROYAL DELUXE VODKA OLD FLORIDA CALVERT 4.75	OLD REPEATER 8 YR. ABC VODKA DRY GIN ABC RUM GILBEY GIN 4.49 QUART
STRAIGHT BOURBON 5 YR. KY. OLD REPEATER 5 YR. COGNAC & 8 YR. KY. 10 YR. BOND & 8 YR. KY. 6 YR. HORN 93 & 8 YR. KY. 5 YR. CERTIFIED 6 YR. KY. 6 YR. CERTIFIED 6 YR. KY. 7 YR. Q. T. 12 YR. MCHENRY KY.	IMPORTED SCOTCH 5 YR. KING GEORGE SCOTCH 5 YR. CERTIFIED 8 YR. WHITE & MACKAY 5 YR. SCOTCH 5 YR. CLAN MCKAY 6 YR. SCOTCH LIQUOR 7 YR. SCOTCH LIQUOR	CANADIAN & BLENDS JACQUIN BLEND EMBASSY BLEND CANADIAN BLACKBERRY CANADIAN CANADIAN SPRINGS GOLD COACH 12 YR. BLEND 8 YR. CERTIFIED CANADIAN WISER 18 YR. CANADIAN
GIN & VODKA RUM 5 YR. GIN RUM VODKA SAXONY VODKA ROYAL DELUXE ABC VODKA ABC RUM GILBEY GIN	WELLER'S SPECIAL RESERVE TANQUERAY QUEEN ANNE SCOTCH 4.99 QUART	1971 VW Square Back Station Wagon equipped with factory air conditioning, automatic transmission, luggage rack and radial tires. Ready to move out at a low price. \$1895
1969 Mercury Monterey 4 door loaded with equipment, beautiful red with white top. Good transportation at a budget price. \$1095	1967 Mercury Colony Park 9 Passenger Wagon loaded with equipment and Super Priced At— \$895	1971 Mercury Monterey 4 door loaded with equipment and finished in light green with green vinyl interior. A real nice car for only— \$2295
1970 Mercury Marquis 4 door, fully equipped including power windows and power seats also AM-FM stereo. \$1995	1969 Lincoln Continental 4 door sedan featuring every Lincoln luxury option and reasonably priced at— \$2395	1970 Maverick 2 door equipped with automatic transmission, big 6 cylinder engine and radio. Truly an economy car. \$995
BUY BEER BY THE CASE AND SAVE! ABC PREMIUM BEER OR CREAM ALE MUNICH BAVARIAN TYPE BEER BURGER BEER SCHAEFER BLATZ BEER MILLER HI-LIFE BEER LOWENBRAU IMP. BAVARIAN BEER	THIS WEEK'S BEST BEER BUY! Sebastiani GENESSEE BEER CATAWBA GANCIA CARDOLLE	THIS WEEK'S BEST WINE BUYS! GRAND VIN BORDEAUX ROSE FROM PORTUGAL VINT. LIERFRÄUMLICH SANGRIA FROM SPAIN PAUL MASSON TAYLOR N.Y. STATE BERTOLLO CHIANTI MIRASSOU PETITE ROSE SAN MARTIN RIESLING BUTY SACE FROM SPAIN MARTINI ROSSI YERMOINT GANCIA ESTI SPUMANTE HARVEY'S BRISTOL CREAM
Hi-Way 17-92 At 436 Casselberry	Hi-Way 17-92 Fern Park	PAUL JONES QT. BLEND SCOTCH 4.99

Silver Repairs
Master silversmith Gordon Laraman will REPAIR, RE-PLATE, POLISH and RESTORE your heirlooms and other silverware to their original beauty. Also gold plating, brass and copper repaired.

PH. 831-1174
OLD SHEFFIELD PLATING CO.
(Est. Brighton, England 1945)
Electro Platers & Silversmith
177A Hwy. 17-92 Longwood

See Our Display Pool
BLUE DOLPHIN POOLS
218 French Ave.
POOL CHEMICALS FENCING
SCREEN ENCLOSURES
Ph. 322-3022 Sanford

HEARING AID
Electone
The remarkable NEW INVENTION For Those With A HEARING LOSS.

FOR FREE DEMONSTRATION IN THE PRIVACY OF YOUR HOME DROP BY OR CALL...
HERMAN KOLEFF 322-0642

FAIRWAY DRUGS
2676 S. Orlando Dr. (17-92) Sanford

A Happy Harvest For Your Hair
Complete Hair Care Products for Normal and Problem Hair.

MERLE NORMAN COSMETIC STUDIO
110 PARK AVE. PH. 323-2631 DOWNTOWN SANFORD

Front End Alignment
2 Front Shocks (HEAVY DUTY)
Reg. \$40 Value
\$29.95

AAA ALIGNMENT
NEXT TO MR. MUFFLER
2421 S. French St. Sanford

IF... You have been looking for UNUSUAL furniture or UNIQUE decor items for your home or office come to...

Conversation Piece
That will TICKLE Your Ego!

AFRICAN SPANISH POLYNESIAN ORIENTAL CONTINENTAL
PH. 824-3836
715 E. Hwy. 436 Altamonte Springs

Arts & Crafts
FREE INSTRUCTIONS
WORK SHOP MON. & THURS. 9:30-12:30
NIGHT CLASSES
EVERY WED. 7 P.M. - 8:30 P.M.

Joy Lu's Frans
ART & CRAFT SUPPLIES - GIFTS
PH. 831-8877 CASSELBERRY

Char's BAR & RESTAURANT
Chuck Schirra Mgr.
OPEN FOR
BREAKFAST 6:30 AM
LUNCHEON SPECIAL
Served Daily
Full Menu
Served Till 10 p.m.

Try Ertha Hudson's Gourmet Specials
2700 S. SANFORD AVE. PH. 322-5958

The Most Beautiful Furniture
The Most Modest Prices
The Entrance To Elegant Living

Romel's
Open Sun. 1-5
Mon. Tues. Thurs. Fri. 9:30-8
Wed. Sat. 9:30-4
360 Longwood Plaza PH. 831-2272

Seminole Lodge
Nursing and Convalescent Residence
Personalized Professional
Nursing Care Since 1964
PH. 322-6755
300 Bay Avenue, Sanford, Fla.

NOW OPEN POTTERY BARN
CERAMICS "M" THINGS
384 LONGWOOD PLAZA
HWY. 17-92
LONGWOOD, FLA. 32750
PHONE 13051 834-4233

INSTRUCTIONS - GREENWARE - FIRING
MORNING - AFTERNOON & EVENING CLASSES

DOES YOUR WIG HAVE THE FRIZZIES? TRADE IT IN
It's worth \$2.00 towards the purchase of a new one (\$5 or over)

Hawaiian Hair Hut
BARBER SHOP
Specializing in Men's, Boys' & Ladies Hair Styles
Phil Hue! -
247 E. Lake St. Longwood 831-3408

FREIGHT DAMAGED FURNITURE
1/2 OFF OR BETTER

NOLL'S FREIGHT DAMAGED FURNITURE SALES
HWY. 17-92 CASSELBERRY

official
WYLER-ETERNA
Watch Agent
Free Gift Wrap
Engraving

Gwaltney JEWELERS
204 S. PARK AVE. SANFORD
WATCH & JEWELRY REPAIR U.S. MINT & USED COMMEMORATIVE STAMPS LAY AWAY PH. 322-4509 MASTER CHARGE

Order Your **SCHOOL RING**
All Schools Available

Car-ben Jewelers Inc.
TIMEX REPAIR CENTER
298 Longwood Plaza (17-92) PH. 831-2285 Longwood

GET THE FACTS regarding the many types of **SELF-IMPROVEMENT** that you can achieve through **SELF-HYPNOSIS**

For information without obligation, phone 322-5758
Seminole County's only Licensed Consultant in Ethical Hypnosis

UNDER NEW MANAGEMENT
VI Mills Owner
featuring **LIVE ENTERTAINMENT**
FRI. & SAT. NIGHTS 8 P.M. - 1 A.M.
Phyllis Jean and the **WHITE LIGHTNING SWINGERS**
Country & Western
SUNDAY AFTERNOON 3 p.m. - 10 p.m.

CLUB DIAMOND
BAR & PACKAGE
Open 7 Days A Week
Hwy. 17-92 DeBary

Famous Recipe FRIED CHICKEN
Open Daily 11 a.m. - 9 p.m.
Fri. & Sat. 11:30 p.m. - 1:00 a.m.
(Hwy. 17-92) SANFORD

OPEN DAILY (including Sun.)
11 A.M. - 9 P.M.
World's Finest BAR - B - Q
CHICKEN, BEEF, PORK, RIBS

Dinners and Sandwiches
take out service
PH. 323-5230

GUY'S HOUSE OF BAR-B-Q
3 Locations To Serve You
2101 French hwy. 441 Sanford
2619 D-S, French Ave Sanford

HERALD BUSINESS REVIEW

For Your Story And Picture call 322-2611 or 831-9993



CO-OWNER Joyce Roberts shows how candles are poured.

At Joy-Lu Fran's Candle Dipping Now 'In'

By ANN SIECZKOWSKI
Well—they've done it again—those talented folks down at Joy-Lu Fran's Craft shop in Casselberry, just south of "The Sportsman Den," who met these criteria, Nan's is the place to go to find just what you want.

With all of these decorator items, container shapes and mold forms available today, candle making has become a new creative venture, whether you are a novice or a professional, you will find this a fun project. Candle styles, popular today, are quite different from those as recently as five years ago. The young folks

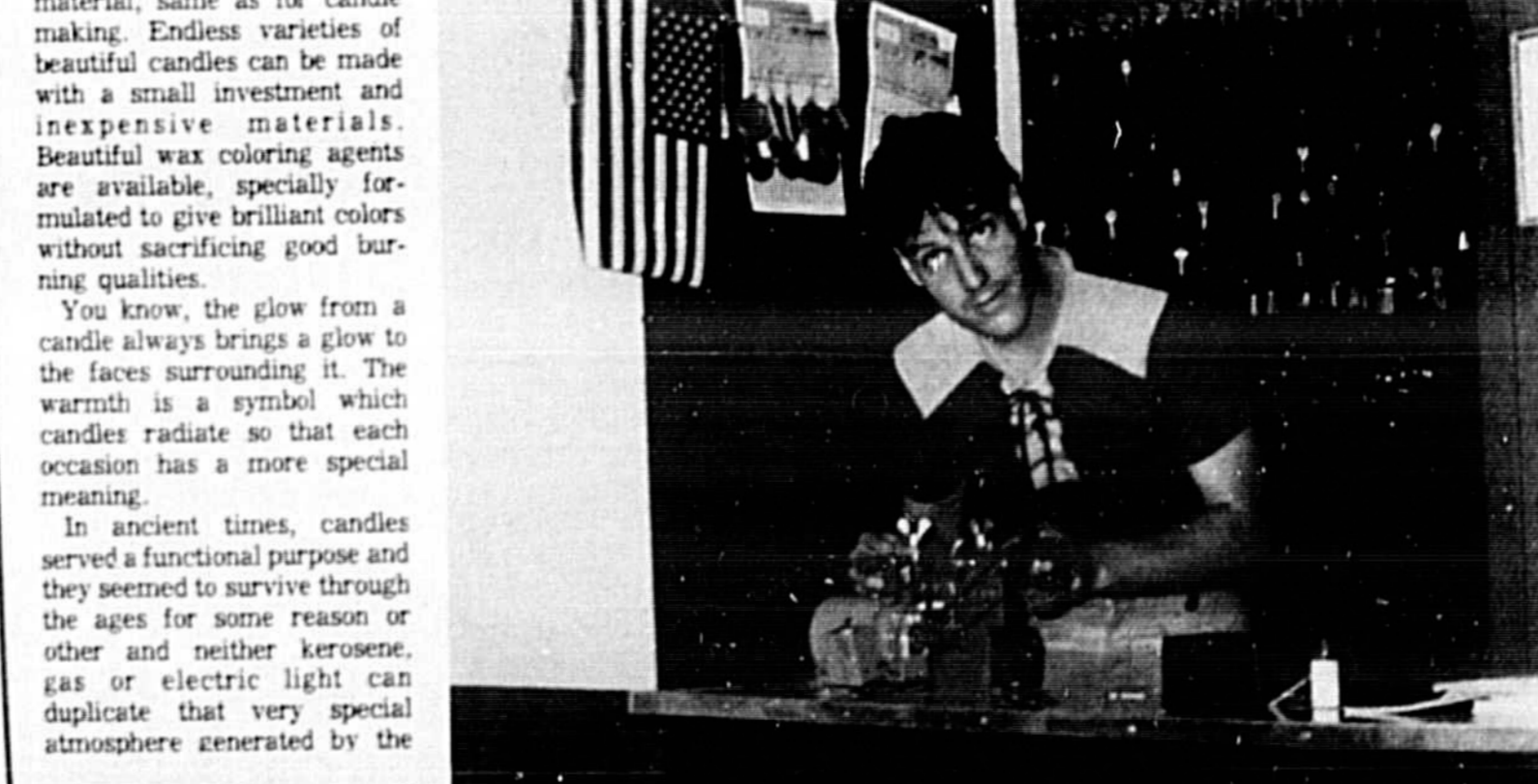

By ANN SIECZKOWSKI
The need for a device to protect people and property from intruders is as old as man. Even the primitive man first attempted to meet this need when he rolled a boulder in front of his cave. More sophisticated methods, but still primitive by today's standards, were used as civilization developed. There were times in history when these methods were reinforced with a magic spell cast upon the door by the local medicine men of high priests of cults.

But today, locks protect almost all of the wealth of the world. Homeowners are protected with small household locks which can be opened by keys. Banks protect savings of the people and businesses in large metal vaults with heavy metal locks which open only at certain times of the day. Locks fasten the doors of the heavy underground vaults where the

PERMANENT SPECIALS
Vitamin E Lemaure Reg. \$22.50 \$17.50
Bonaf Protein & Oil \$20.00 \$15.00
Clairf Chroma Reg. \$17.50 \$15.00

Frostings
Reg. \$17.50 \$15.00

WEISS LOCKS
Durable Bunting Hi-Fit U.S. Flags
Made of Government-quality fog bunting with printed stars and sewed stripes. All fast colors. Strong canvas headers and brass runners.

3' X 5' U.S. Flags \$7.50 ea.
George Stuart
2708 Sanford Ave. Sanford

Just Browse Around Exciting Gifts At Nan's



NELLIE Coleman displays a line of fine gift items at Nan's Gift Shop on Elm Avenue.

By ANN SIECZKOWSKI
It is only natural for you to love fine things, beautiful things, elegant, and exclusive things. For those of you who meet these criteria, Nan's is the place to go to find just what you want.

Nan's Gift Shop is located at 201 Elm Avenue. It is housed in the same building with Ace Hardware. (To tell the truth, if it keeps growing, it will occupy most of the building.) It is operated by the talented and artistically inclined Nellie Coleman (her husband, Boyd operates Ace Hardware, you know).

Every time we go into that shop, we see more new and different and positively exciting gift items. When that gal goes shopping, Sanford gift buyers

On Park Avenue, Sanford New Lock Shop Opens

By ANN SIECZKOWSKI
gold of nations is held in safe keeping.

There are many kinds of locks — the spring lock, the padlock, the cylinder lock, combination lock and the time lock.

What do you know about locks? Could you open one? Could you do without your valuable key to open your particular lock. What would you do if your key broke? Or if you lost your only key?

I'll tell you what to do. Call Thomas A. Kutschenreuter, a new, young businessman in Seminole County who has just opened shop at 202 South Park Avenue. The name of his business is Mid-Florida Locksmiths. He is a graduate of the Locksmithing Institute in New Jersey.

Thomas became interested in the business when he was working in a hardware store in Washington (D.C.) area where he lived. He took some courses in opening and changing locks

CUSTOM DRAPERIES
Homes - Offices - Apartments
Residential & Commercial
Fine Tailoring - Fine Fabrics
Choice of Styles

WE CARRY KIRSCH RODS AND ACCESSORIES

SEMINOLE DRAPERY
2708 Sanford Ave. Phone 322-2304 Sanford

IGO
AUTOMOTIVE REPAIR SERVICE
REPAIR AT THE RIGHT PRICE
TUNE UPS • CAR AIR CONDITIONING
BRAKE SERVICE • CARBURETORS
VALVE JOBS

OPEN DAILY 7:30 - 5:30
PHONE 831-9349
OFF. S. 434 between 17 92 & 14
LONGWOOD INDUSTRIAL PARK

Special! CHICKEN Dinner
Includes:
1 Pk. Chicken
French Fries
Cole Slaw - Rolls
\$7.10

All Foods Cooked in Peanut Oil
for Phone Ahead Orders 322-9442
2100 S. French Ave. Sanford

FOR HOME OR FARM
PESTICIDES - FERTILIZERS - BULK SEEDS
Hardware for the Farm or Home
NELSON FLORIDA ROSES
WE NOW HAVE
STRAWBERRY PLANTS

GardenLand
OPEN DAILY 8 A.M. - 5 P.M.
1400 W. FIRST ST. PH. 323-6430 SANFORD
(In The Old Kilgore Seed Store Bldg.)

IT'S OUR MOVE
TO 221 MAGNOLIA AVE.
SOON!

Celery City Printing CO. INC.
300 W. First St. Ph. 322-2581 Sanford

SNAPPER COMET
The Riding Mower
That Works Like a Beaver
TOUGH - DEPENDABLE - STRONG
Attachment for accumulating grass, leaves, pine needles and light litter.
Can mow, trim, aerate and mulch with the proper implements.

FREE DEMONSTRATION
SMITTY'S SNAPPIN' TURTLE MOWER
2715 Orlando Dr. Sanford (305) 322-2811

Entertainment
By **MIAMI**
Fri. & Sat. Nites
HOT LUNCHEON SPECIALS
SANDWICHES
OPEN SUNDAY
3 p.m. - 2 a.m.
HAPPY HOURS - 7
\$6 Drinks & Hours of Delicacies
We Cater Private Parties

CLUB HUI
Downtown Sanford

If You've Got It...
You've Got It And
EDWARD'S SHOES
Has Got It!!

Vale's Junior Shoeland
390 LONGWOOD PLAZA
HWY. 17-92 LONGWOOD
PH. 831-7252

Rld-a-Bug
"I think it was something late..."
Kills bugs for up to six months
and saves you about \$100 yearly in costly pest control services.

SEMINOLE HARDWARE & WESTERN SUPPLIES
LONGWOOD PLAZA
Hwy. 17-92, Just North of 434
PH. 838-5823

EXPERIENCED PERSONNEL
LATEST EQUIPMENT TO ASSURE FACTORY SPECIFICATIONS
ALL WORK GUARANTEED
SEMINOLE PAINT & BODY
David Redvine Owner
15 Years in Sanford Area
2340 S. Myrtle Sanford

OTTO'S HOFBRAU HAUS
Buffet
HOT and COLD
ALL YOU CAN EAT
Lunch \$1.25
Dinner \$1.95

HAPPY HOUR
4 p.m. - 8 p.m.
Hi Balls 50c
Lounge Open 10 a.m. - 11 p.m.
PH. 322-9716
2544 Park Ave.

IT could happen To You!
IF IT DOES CALL US
MID-FLORIDA LOCKSMITH
24 Hr. Service
323-6901
202 S. PARK AVE.

WHERE THE ACTION IS
Hwy. 17-92 - Longwood
1 Mi. South of Big Tree
PH. 831-3433
Engines, Transmissions
Starters - Fan Belts, Doors
Tires - Wheels Etc.

ACTION Auto parts
FREE Parts Locating Service
Throughout the Southeast
Largest Auto Parts House
in Seminole County
WRECKER SERVICE

USED AUTO AIR CONDITIONERS
\$75 up

GIFTS BY NAN
Come In And Browse
See Our Selection of Unusual Gifts.

Light's Fantastic
A fascinating burst of Plexiglas rods mounted over a revolving color wheel. Tall rectangular frame around sculpture is a genuine Plexiglas. Light flows up rods and bursts from ends in a show of ever-changing colored sparks.

COME IN AND SEE OUR DISPLAY
201 S. ELM PH. 323-7121 SANFORD
(In The Ace Hardware Bldg.)

for Better Living
This Month's SPECIAL EXTRA BATH NEW KITCHEN

Roof Repairs
"We Handle The Whole Ball Of Wax!"
Call AC-305
Remodeling 322-7029

B.E. LINK Construction
Vihlen Road, Sanford

JUST FOR FUN TRY ONE OF OUR CRUISES
COST: LESS THAN YOU THINK
AS LOW AS \$95
for further information call or stop by

Sun Travel Agency
Authorized Agent For All Airlines
And Steamship Lines
No Charge For Our Services
Tel. 323-4650
Open Thursday Nights By Appointment
2017 S. French Ave. Sanford, Florida

What's clean and quiet and nice and warm?
Other than a baby, that is. A Singer electric furnace, it's a lot of other things, too. Like inexpensive to install because you don't need a flue. Like easy to take care of.
It's also ready for conversion to Singler air conditioning anytime you want it.
And it's as dependable and as safe as any electric appliance in your home.
Give us a call or come in and see us. We'll tell you how to keep your baby warm. No matter how old she is.

Comfortmaker heating & air conditioning by SINGER
CALL 322-6390 FOR FREE ESTIMATE
SANFORD HEATING & AIR CONDITIONING
2809 S. SANFORD AVE. SANFORD

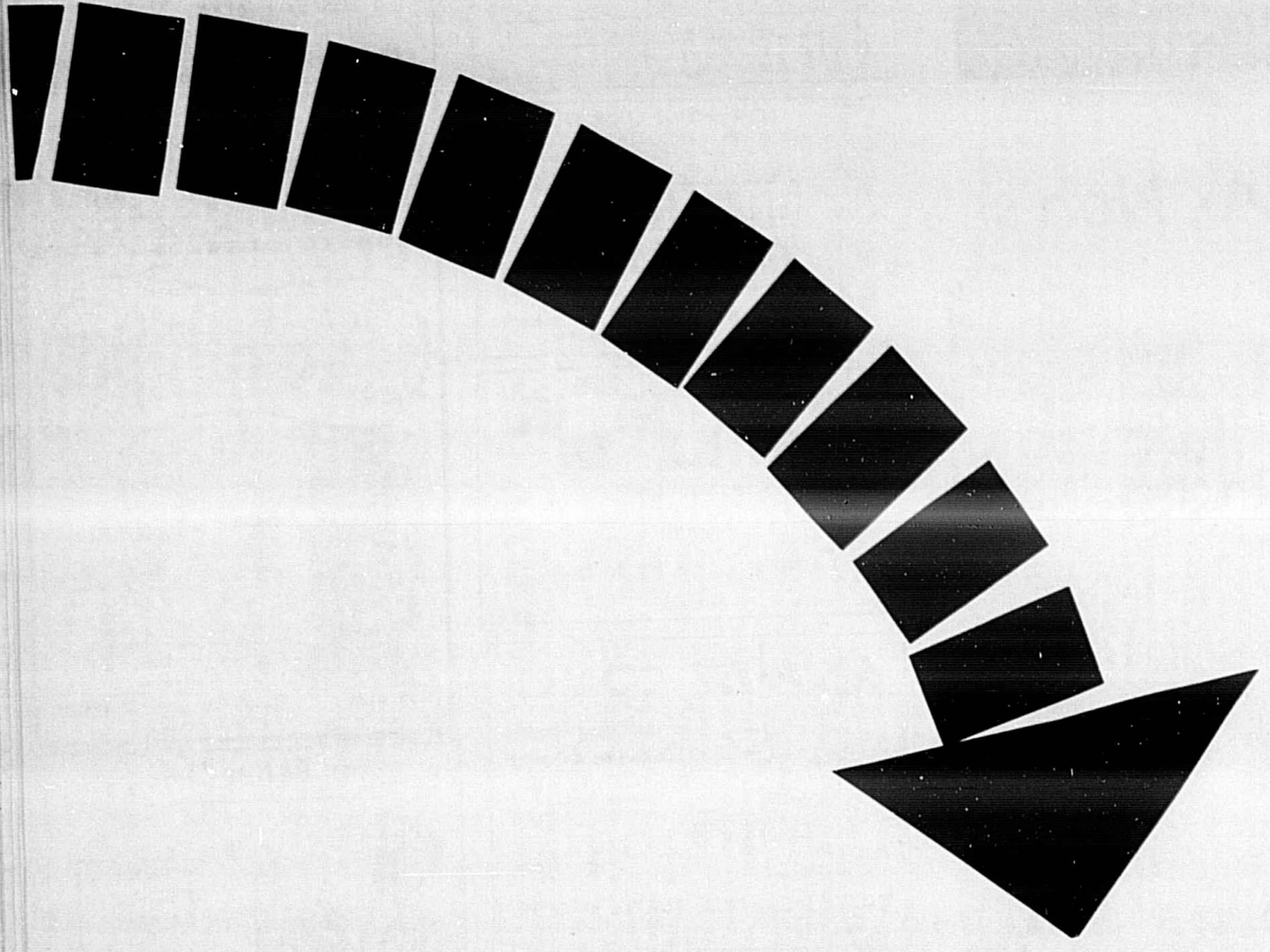

Feel Like You've Been Missing Something?

The Sanford Herald Carries All The Local News—With An Average Of Over 450 Pages Of Local Interest Each Month. Why Not Get In On The "News"

35¢ A Week
 Phone: 322-2611 or 831-9993

SUBSCRIPTION COUPON

Name _____
 Address _____
 Start Date _____

Mail To: THE SANFORD HERALD
 P. O. BOX 1657
 SANFORD, FLA. 32771

Sanford Herald

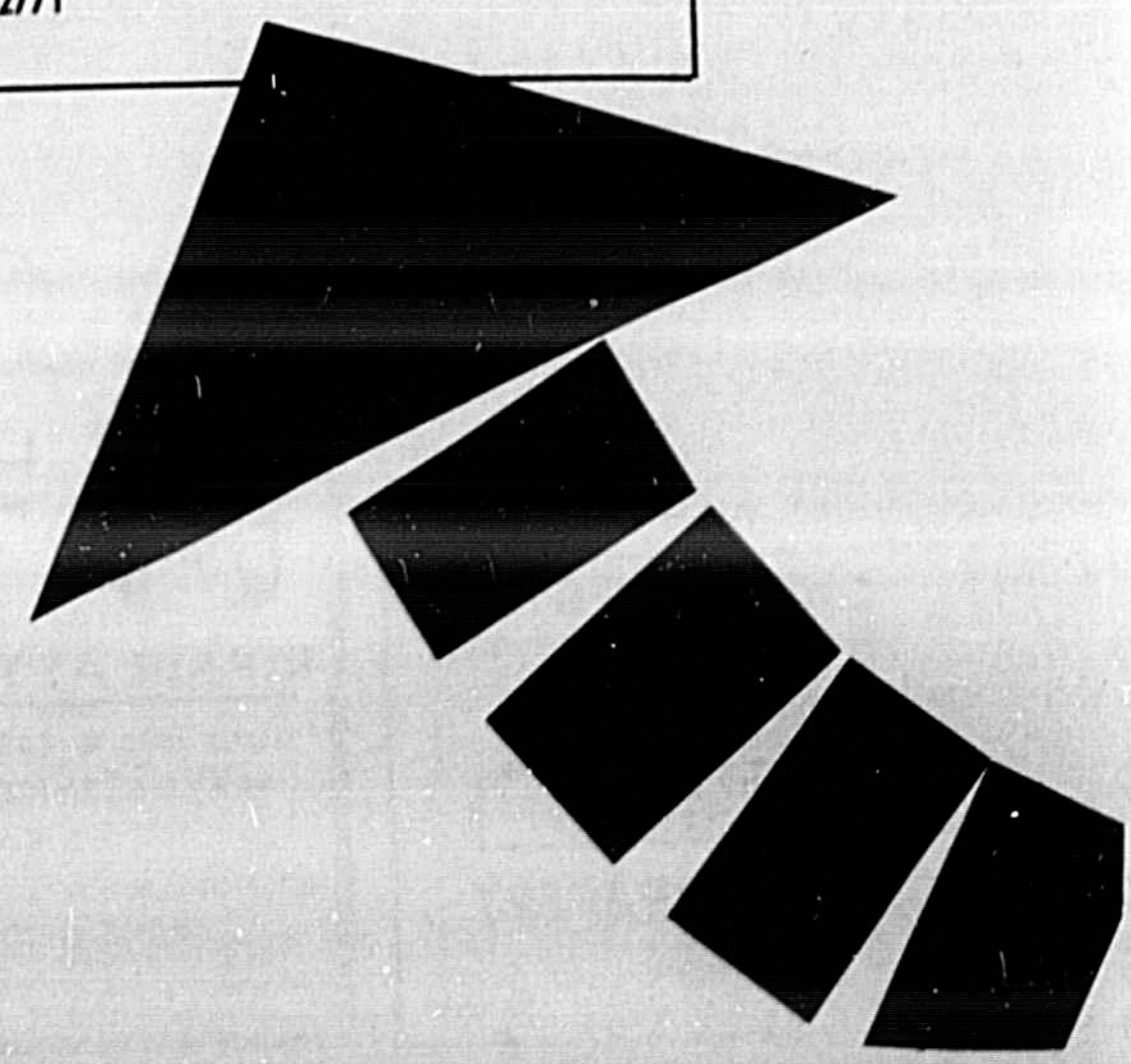

Advertising Supplement to the Sanford Herald, Tuesday, October 3rd, 1972.

J.M. FIELDS DISCOUNT DEPARTMENT STORES

IBIG BUYS

Use your J.M. Fields Credit Card. We also accept all major credit cards. Accounts used exclusively for Major Appliance purchases.

44-qt. flip-top basket
 Use as hamper or waste basket.
 Regular 1.49
99¢
 Save 50¢

32-gallon trash barrel
 Heavy-duty plastic. Rib design. No wobble or split.
2.99
 Special

Viscose rayon rug runner
 2' x 6' ribbed runner. Cushioned backing.
 Regular 2.29
1.99

2-ton support jack stand
 Supports 4,000 lbs. Lightweight, compact.
 Regular 3.49
1.99
 Save 1.50

Shredded foam bed pillow
 22 x 26 with satin floral print cover.
2 for \$5
 Save 98¢

Save 32.99! Aluminum-frame 10 x 7 steel storage shed
\$97 Regular 129.99

- Rust-resistant zinc undercoating - baked enamel finish • Stainless-steel screws
- Steel gable plate • All-locked into place • Nylon door rollers • Formed-steel corners • Sturdy ribbed panels • 4 nylon guide buttons • plus more great features.

Inside Dimensions	Outside Dimensions	Color
8' x 7' x 7'	8' 1/2" x 7' 1/2" x 7' 1/2"	323
8' 6" x 7' 6" x 7' 6"	9' 1" x 8' 1" x 8' 1"	576
9' 6" x 7' 6" x 7' 6"	10' 1" x 8' 1" x 8' 1"	577

10' x 10' Shed **128**
 Regular 159.99
 10' x 12' Shed **168**
 Regular 199.99

G.E. Super flashcubes
 3-cube sleeve 4 shots each cube.
69¢
 Special

30-pack scouring pads
 Rust-resistant shine aluminum.
 Regular 69¢
59¢
 Special

Sale! Work shoes built for comfort For Women
 White duty shoes in oxford or slip-on styles. Sizes 5-10.
 Regular 3.29
For Men
 Black or green, with oil-resistant soles and uppers. 7-12.
 Regular 3.29
Save \$2
 1.29 Your Choice

3-speed phonograph
 Solid state. Plays 78, 45, or 33 RPM. Handy carry handle.
12.99
 Special

19" 3 H.P. lawn mower
 4-cycle auto-choke Briggs & Stratton engine. Easy start.
 Regular 49.99
\$44
 Save 5.99

J.M. FIELDS DISCOUNT DEPARTMENT STORES

IBIG BUYS

Velvet-look rayon & acetate draw drapes
 Washable, easy-care drapes in velvet-look white, black, green, or red. Choice of 63" or 84" lengths. Use several pairs for wide windows. 63" Regular 3.99
2.99
 Save 1.00
 84" Length Regular 4.99 3.99

Iridescent blue gift Carnival Glass
 The Heirloom beauty & glowing color of original Carnival Glass! Pitcher, egg-center bowl, gariand bowl, hostess plates, hen-on-nest & more! Regular 1.99-2.59
2 for \$3
 Save to 1.09

VALID THRU OCT. 7TH 11:11AM
Our Own JMF Bras
 Washable. Regular 1.29
89¢
 with this coupon
 Saver! 40¢

VALID THRU OCT. 7TH 11:11AM
Enamel toilet seat
 Combined. Regular 3.69
1.99
 with this coupon
 Save 1.70 Limit 1

VALID THRU OCT. 7TH 11:11AM
K2R Spot Lifter
 Textze. 8-oz. Regular 1.59
99¢
 with this coupon
 Save 60¢ Limit 1

VALID THRU OCT. 7TH 11:11AM
Jergens Lotion
 13.3-oz. 1/3 More Free
 The 19 Size
69¢
 with this coupon
 Limit 2

VALID THRU OCT. 7TH 11:11AM
Sweet 'n' Low
 100's. No aftertaste!
39¢
 with this coupon
 Limit 2

VALID THRU OCT. 7TH 11:11AM
FDS feminine spray
 3-oz. The 150 size
77¢
 with this coupon
 Limit 2

VALID THRU OCT. 7TH 11:11AM
3 bars Jergens soap
 Mild foaming soap
3 for 19¢
 with this coupon
 Limit 8 bars

DOUBLE the DIFFERENCE
J.M. Fields exclusive PRICE PROTECTION POLICY. Within 10 days of purchase and upon furnishing proof that the identical item advertised here is available for less, J.M. Fields guarantees the difference!

CAPEHART AM/FM multiplex compact 42"
Credenza with 8-track player. Powerful 120 Watt 4-speaker system! With BSR changer and 8-track player. Attractive console style.
159.95

CAPEHART AM/FM multiplex stereo console, 8-track tape player
Compact 44" credenza. With 120 watt power, 6 matched speakers, BSR deluxe changer, Handsome!
199.95

J.M. Fields exclusively Account used exclusively for Major Appliance Purchases!

Your Choice!
249.95

Contemporary cabinet

CAPEHART AM/FM multiplex stereo console with 8-track and deluxe BSR changer
Choice of 3 exciting cabinet models... Contemporary, Mediterranean, or Early American... all in handsome wood finishes! Rugged 60" wide consoles with 120 watts of power, 8 speakers for full, rich sound!

Early American cabinet

Mediterranean cabinet

Prices slashed during Fields great SPECTACULAR

J.M. Fields TV and STEREO

It's here! The Sight 'n Sound savings event you've all been waiting for!

SYLVANIA 12" diagonal compact black & white portable
High performance in a compact chassis! Solid state tuning.
89.95

SYLVANIA 11" diagonal solid state color television
Easy service with new plug-in transistors! Great colors! 5" speaker.
399.95

SYLVANIA 17" diagonal TV with Perma-Lock® color!
The anti-goofer color tuning that never forgets! Solid state.
349.95

COLOR

SYLVANIA 25" diagonal deluxe color TV in handsome cabinet
Rugged Early American cabinet! Perma-Lock® line tuning for great picture from channel to channel! With non-glare screen. Solid state chassis. — 90%

SYLVANIA 18" diagonal black & white TV with easy-tuning system
Get great picture and sound reception on UHF or VHF. Automatic fine tuning.
139.95

SYLVANIA AC/DC 12" diagonal black and white compact portable television
Easy to carry from room to room! A great little solid state portable. UHF and VHF.
99.95

Score Big Savings on Famous Shotguns & Rifles!

Save \$12 Marlin 22 cal. rifle
1. Comes complete with 4x scope and mounts! Boasts bolt action, shoots long-long rifle & 22 short! With 7 clip magazine. Great buy! #20
29.99
Regular 41.99

Save \$9.11 Marlin repeating shotgun
2. An ideal shotgun for upland game, water fowl or deer! Bolt action with 2-shot clip magazine. Insures fast repeat shots. Hurry! #50 Regular 47.99
38.88

Save \$27 Winchester 30 30 rifle
3. Ideal deer rifle with walnut finish hardwood stock. 37.3" overall length, 20" barrel and 13" pull length. 6-shot magazine. #94 Regular 93.99
66.99

Save \$23 automatic shotgun
4. 12 gauge, 5-shot low recoil automatic shotgun. Remington proof steel barrel, convenient positive cross bolt. Walnut finish. #48 Regular 132.99
109.99

Save \$11.11 Savage automatic rifle
5. Fires 15 shots on fast as trigger is pulled, automatic loading. Equipped with 6 line scope and mounts. Special price. #1971 Regular 49.99.
38.88

Canuck shotgun shells
In 12, 16, 20 ga.
188

Heavy duty gun case
Rugged vinyl case. Handily sized and lined. Front or full-length zipper.
4.99

Hunters camouflaged light folding stool
Sturdy 1" aluminum tubing. In no-reflection finish.
5.99
SWE '12

Gun cleaning kit at a money saving price
3-section aluminum rod, patches, gun slick, solvent, oil and more.
2.99

Famous Coleman stove with 2 burners
The most popular stove for camping. Clean burning. Save.
12.49
SAVE 2.50

Tremendous savings on Sporting Goods!

\$1 \$2 \$3 \$4 \$5

1.00 Mirelure for the big ones. Limit 2 per customer.	2.00 Minnow trap. A fishing must.	3.00 Old pal 2-tray tackle box. 15 compartments.	4.00 Zebco #77 reel-n-rod. For the beginners.	5.00 Johnson 125 reel and rod combo. Great fishing value.
1.00 Famous salty dog shrimp. Perfect for big trout. 3 for 1.00	2.00 Old Pal bait bucket. 10 qt. rot-proof.	3.00 Capt. Fishfinder spincast reel. Complete with line.	4.00 Flo-troll bait bucket. Keeps bait alive.	5.00 Capt. Fishfinder spin cast reel. Heavy duty — fresh water.
1.00 Cone pole fishing kit. Pole, line, hook, float.	2.00 1-piece spincast rod. 6 ft. fiberglass.	3.00 South Bend bait reel. For all fresh water.	4.00 Long handle shrimp net. Cotton-logged net.	5.00 South Bend 730 spinning reel. For fresh or light salt.
1.00 Cone pole fishing kit. Pole, line, hook, float.	2.00 Aluminum landing net. Save gill handle.	3.00 Single action fly reel. Easy take-down.	4.00 Sargent pliers. A tackle box must.	5.00 Famous brands rod reel. South Bend, Garcia, Rose.
1.00 Cone pole fishing kit. Pole, line, hook, float.	2.00 Aluminum shad net. Ideal boat catches.	3.00 Aluminum shad net. Ideal boat catches.	4.00 Camouflaged hooded parka. Lightweight mesh.	5.00 Assorted fly rods. Make them last.

Soft & casual
Attractive vinyl bags in black, brown, or tan with contrast trims. Many with inside pockets, zippers.
Regular 3.99
\$3
Save 99¢

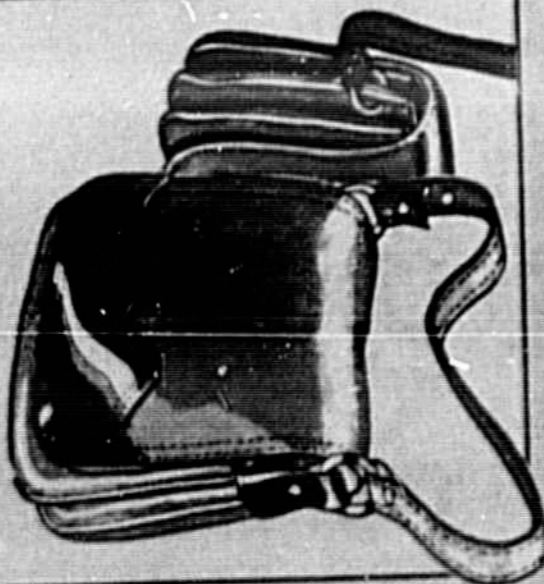

Girls' washable acrylic sweater and skirt set
Bonded acrylic skirt & acrylic knit sweater in new Fall colors. Crew neck sweater with chain-trim skirt; turtle-neck pullover with button-trim skirt; cardigan sweater with 2-pocket skirt. 7-14.
Regular 5.99
4 88
Save 1.11

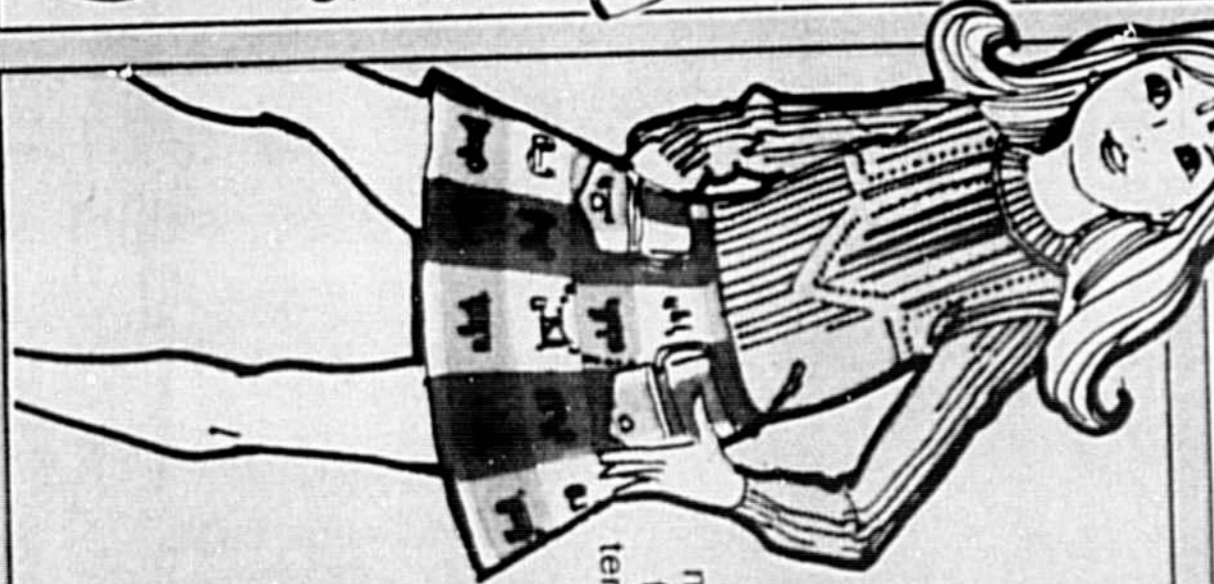

MEN'S VINYL SHEER JACKET
Quilt lined, knit cuffs and collar. Colors: 5, M, L, XL.
Regular 5.99
SAVE \$2
5 99

TREMENDOUS SAVINGS ON JACKETS FOR THE FAMILY!



BOYS' QUILT LINED JACKET
Cotton Twill Jacket with spread collar. Colors: 5, M, L, XL.
Regular 4.99
SAVE \$2
4 99

GIRLS' HOODED SPORTS JACKET
Quilted nylon in 12 colors. Per. for Fig. 4-14.
Regular 5.99
SAVE \$1.99
5 99

INFANTS' NYLON HOODED JACKET
100% nylon in solid colors. Per. for Fig. 6-18 mos.
Regular 3.44
SPECIAL
3 44

Men's flare-leg 100% cotton corduroy jeans
Cargo style pockets, wide-waist & beltloops combine for latest styling! Machine washable.
Regular 6.99
\$5
Save 1.99

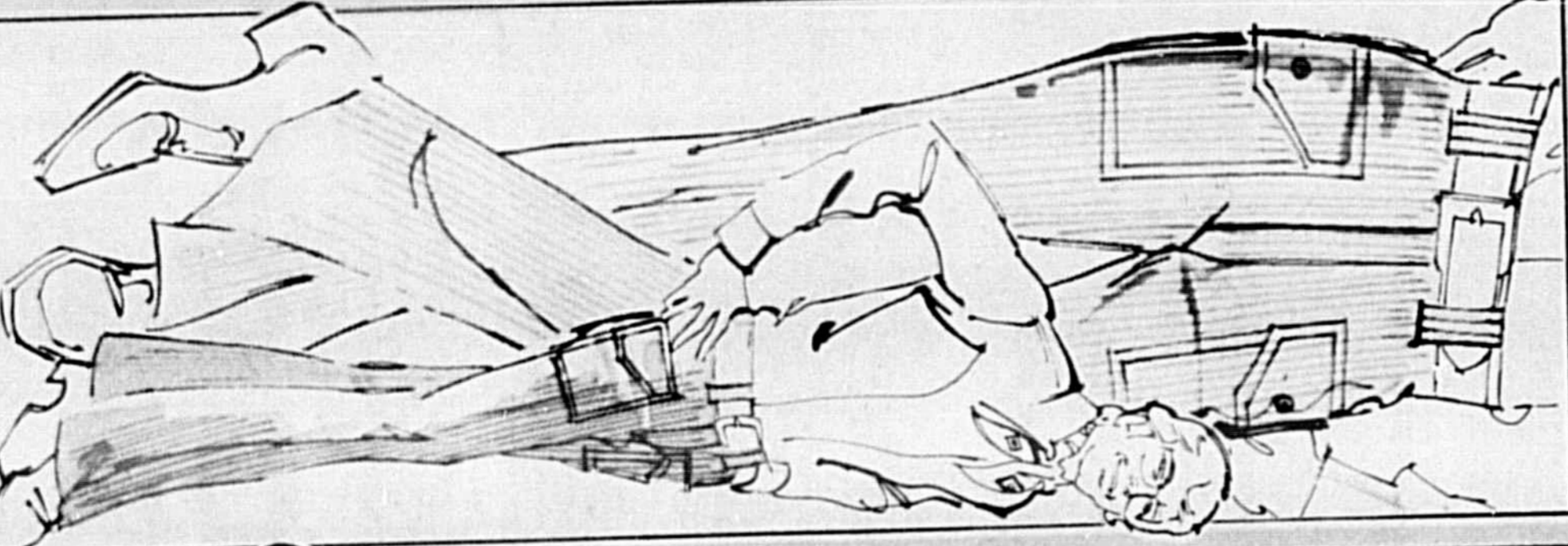

J.M. FIELDS
DISCOUNT DEPARTMENT STORES

You don't need cash to save... Charge It! Shop the convenient way with a handy J.M. Fields Credit Card. We also accept MasterCard and BankAmericard accounts except on minor items. We also offer a J.M. Fields Installment Account! In store only.

Special! Portable color TV with 19" screen.*
Only \$299
This is the lowest price ever offered for a 19" color TV. It's your big chance to get a real bargain. The set features automatic fine tuning (AFT); memory VHF fine tuning; reset circuit; contrast; never controls; and more. All these features at an amazingly low price!

Sale! Save 60.95 on a 25" color TV in these 3 styles.
Your choice \$489.

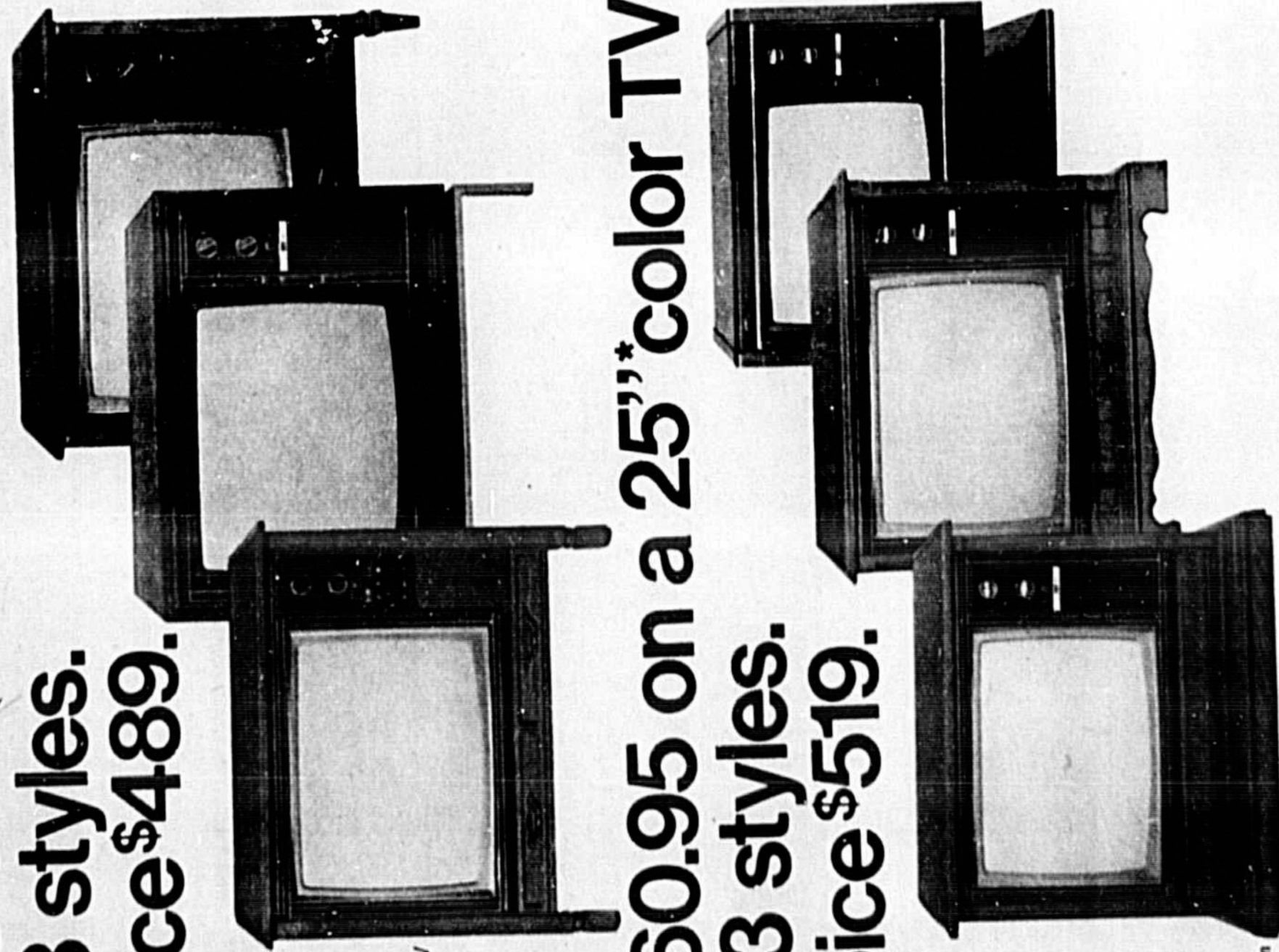

Reg. \$49.95. Choose from 3 styles: Early American and Mediterranean styles. These TVs combine fine furniture craftsmanship with modular chassis construction. Each TV features automatic fine tuning, "Chroma-Brile" picture tube and "Quick-Pic".

Or save 60.95 on a 25" color TV in these 3 styles.
Your choice \$519.

Reg. \$79.95. Decorator features give these 3 color TVs a Modern, Early American or Mediterranean style; each cabinet is designed and mitered as a single piece. They all feature "Chroma-Loc", automatic fine tuning, "Chroma-Brile" picture tube, "Quick-Pic" modular chassis, *screen massed diagonally.

Sale prices effective thru Saturday, Oct. 7th. Use the JCPenney Time Payment Plan.

JCPenney
We know what you're looking for.

During Penney Days
save 20% on our Vibrations group.
This is what we call a sale!

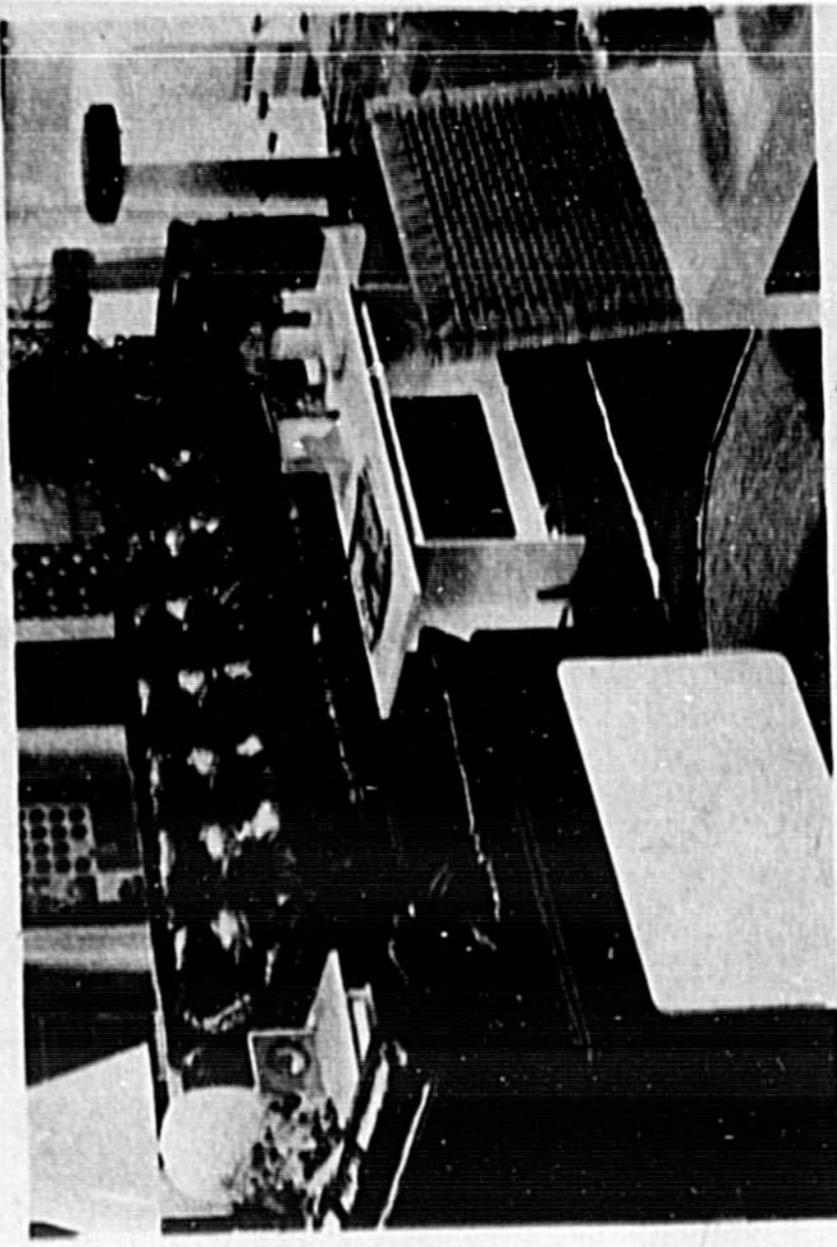

Save \$40
Reg. \$199. Sale \$159. 99" Sofa is covered in "wet look" vinyl. Features 3 1/2" polyurethane upholstery and polyurethane base.
Pouf-seat. Reg. \$159. Sale \$127
Chair. Reg. \$113. Sale \$90
Cocktail table. Reg. \$45. Sale \$36
End table. Reg. \$45. Sale \$36
Bar. Reg. \$146. Sale \$118
Bar stool. Reg. \$80. Sale \$64

Save 20% on Sleigh group, too.

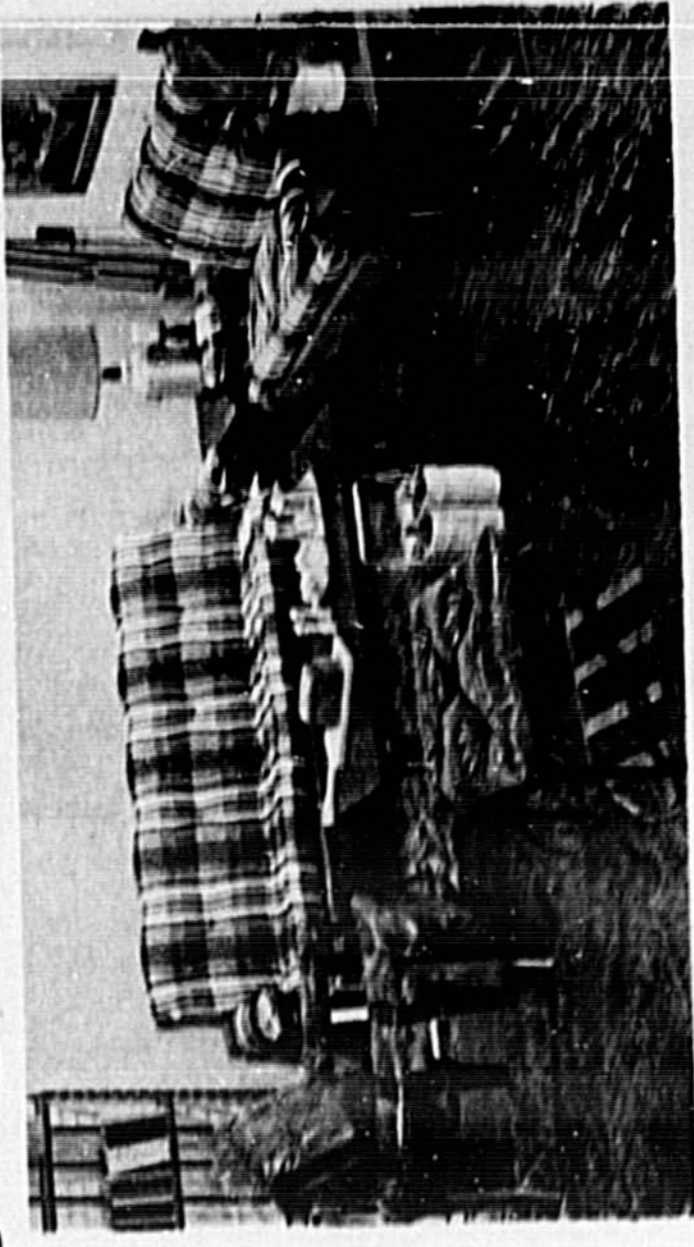

Save \$56
Reg. \$279. Sale \$223. "Sleigh" sofa is covered in olefin/vinyl combination. Kiln dried oak frame; polyurethane foam upholstery.
Love seat. Reg. \$229. Sale \$183
Chair. Reg. \$143. Sale \$113
Cocktail table. Reg. \$85. Sale \$52
End table. Reg. \$65. Sale \$52
Ottoman. Reg. \$75. Sale \$60

Sale prices effective thru Saturday, Oct. 7th. Use the JCPenney Time Payment Plan.

JCPenney
We know what you're looking for.

SANFORD, FLORIDA
SANFORD PLAZA
10 AM to 9 PM
Monday-Saturday

SUPPLEMENT TO
SANFORD HERALD
TUESDAY, OCTOBER 3, 1972



Special recliner heats and vibrates.

\$99.95

- Wipe-clean supported vinyl
- 3-position balanced reclining
- Polyurethane foam seat cushion
- Relaxing heater-vibrator unit is U.L. listed
- No-sag spring construction
- Self-storing button tufted footrest

Use the JCPenney Time Payment Plan.

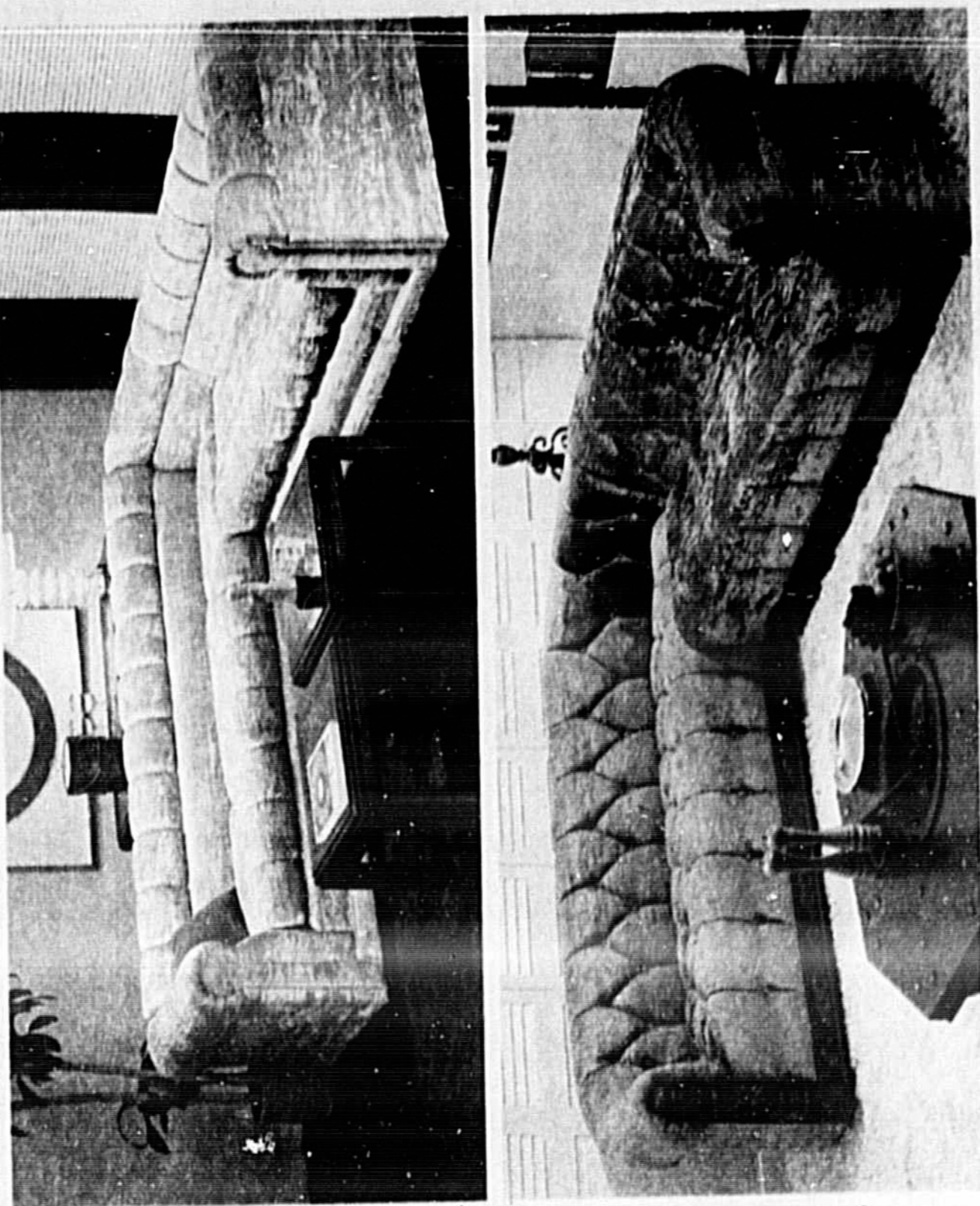

\$399

Spanish style 2-pc. sectional sofas of polyurethane foam and dark fruitwood finish on exposed trim. No-sag spring base and back, kiln dried hardwood frame. Rayon velvet in Barcelona.

\$399

Contemporary style 2-pc. sectional sofa is covered in plush 100% rayon velvet. It features loose seat foam, polyester wrap, and no-sag spring construction. Available in martin white.

Contemporary and Spanish style 2-piece sectionals. Both covered in rich-looking velvet. Both at everyday low prices.

Save \$100 on this 4 piece Mediterranean style group with an amber pecan finish.

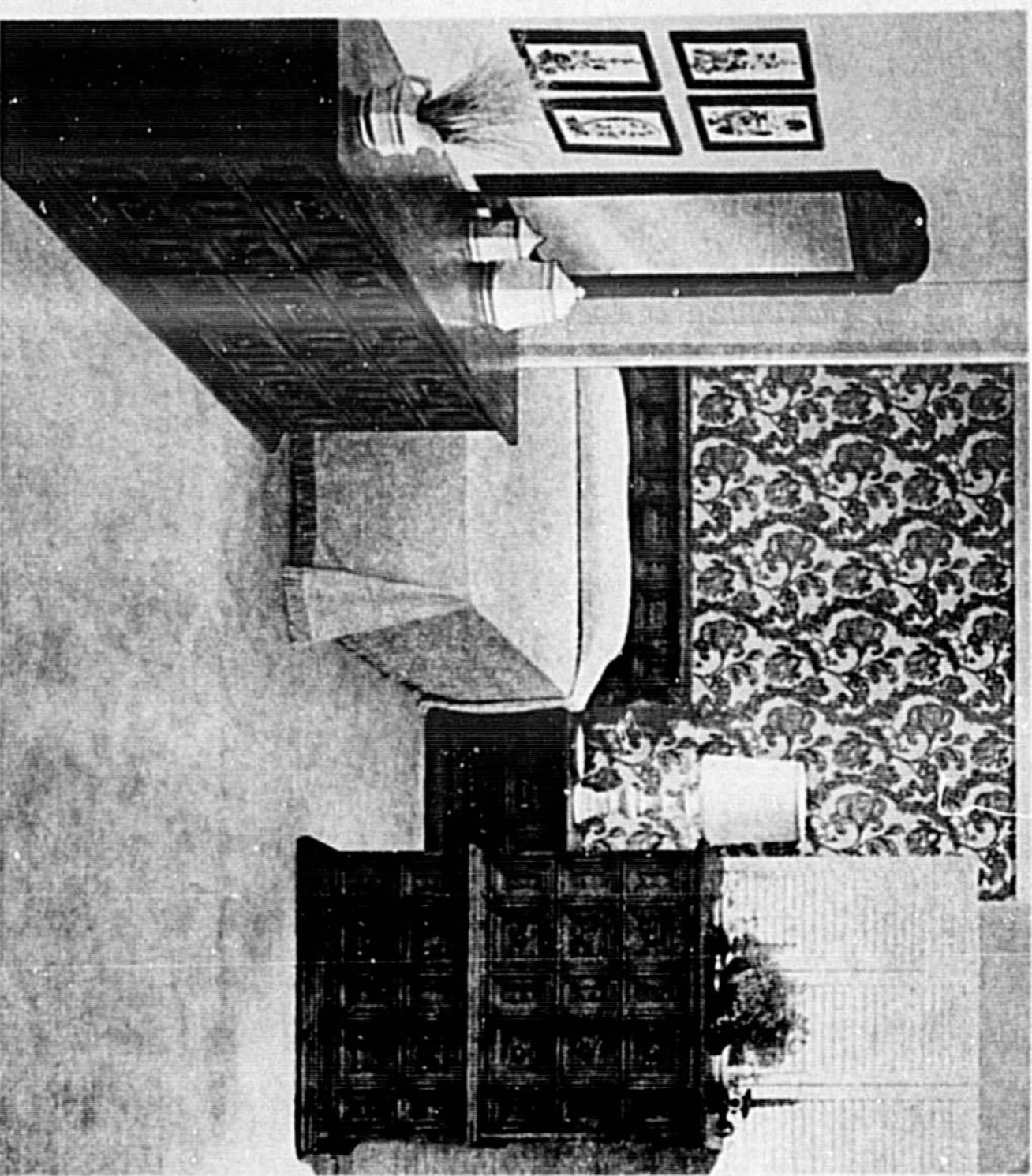

Save \$100

Reg. \$459. Sale \$359. This 4-pc. bedroom set includes triple dresser, mirror, full size headboard, and bed. Features a double engraved pecan finish over select veneers and hardwoods.

Night stand, Reg. \$76. Sale \$60
King size headboard, Reg. \$105. Sale \$84
Sale prices effective thru Saturday, Oct. 29. Use the JCPenney Time Payment Plan.

Big savings on bedding, too.

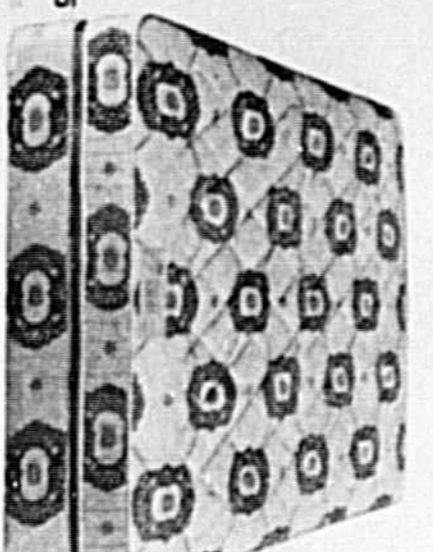

Save \$10

Reg. \$9.95. Sale \$8.95. Twin or full size mattress or box spring. Cotton felt, flexolator insulation, rayon sateen covers quilted to polyurethane foam.

Queen set, Reg. 109.95. Sale 109.95

King set, Reg. 209.95. Sale 229.95

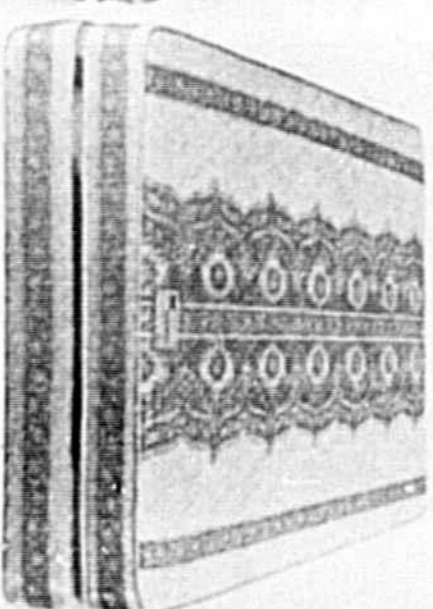

Save \$20

Reg. 79.95. Sale \$9.95. Twin or full size mattress or box spring. Extra resilient coils, layers of polyurethane foam multi-fibered quilted to rayon sateen cover.

Queen set, Reg. 229.95. Sale 179.95

King set, Reg. 429.95. Sale 389.95

Deluxe metal bed frame, \$15

JCPenney
We know what you're looking for.

Sale! Price

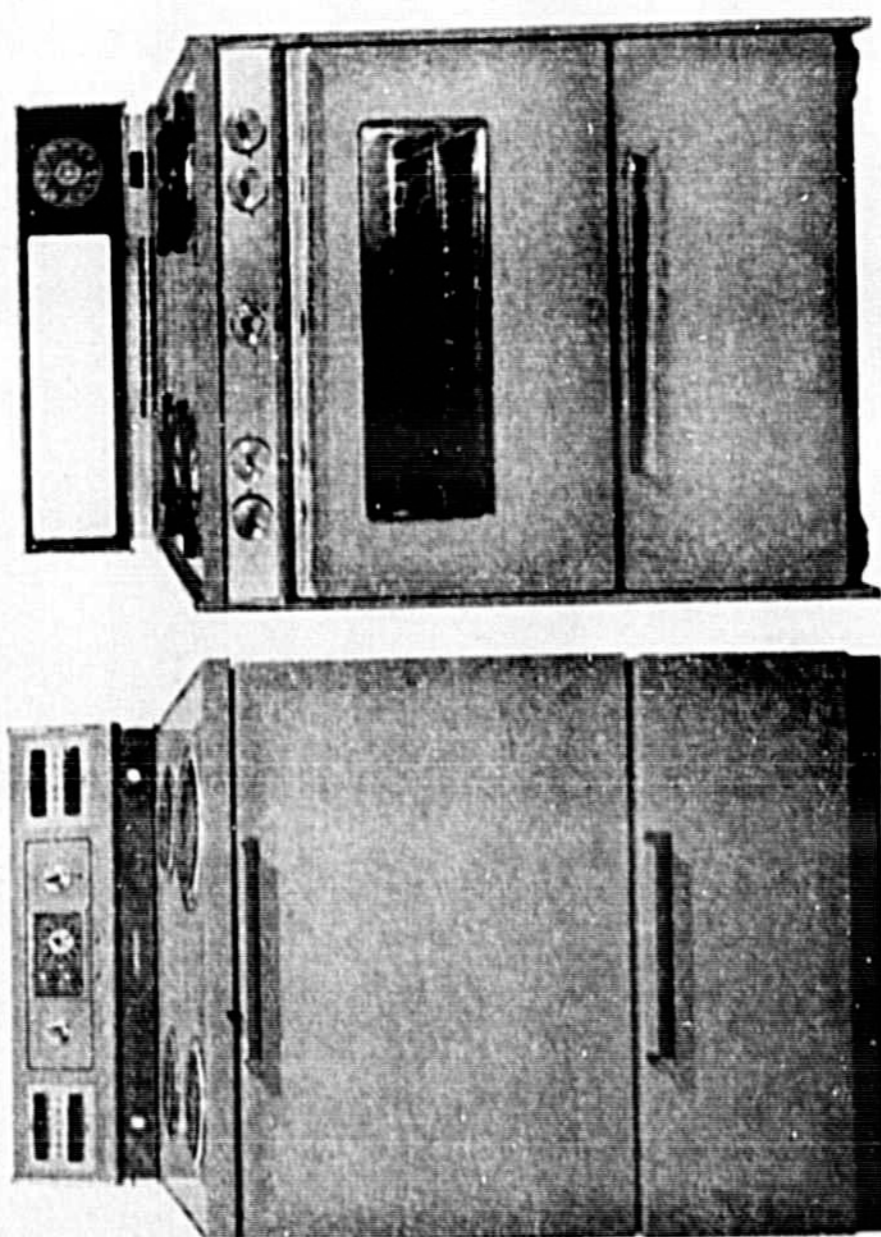
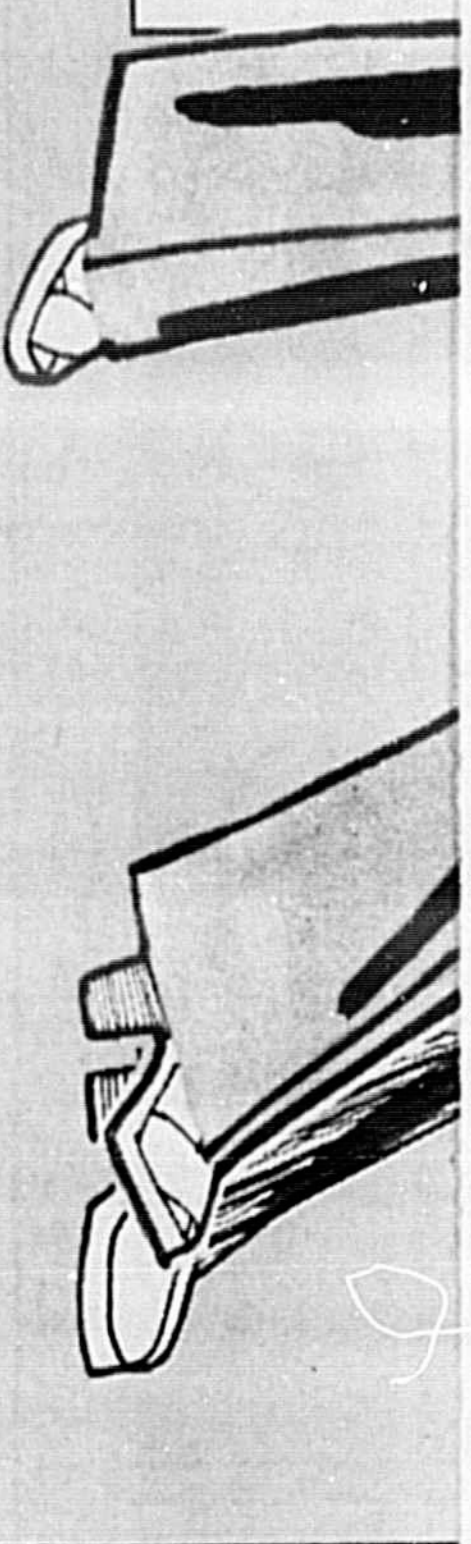

Save 40⁹⁵

Save 30⁹⁵

Reg. 269.95. Sale \$229. 30" electric range with a Radiant Clean oven. It cleans itself! Features a self-cleaning clock. Has a storage drawer for pots and pans. Choose from 3 colors at no extra charge.

Reg. 229.95. Sale \$199. 30" gas range with EverClean oven panels that clean themselves during regular use and no match ignition. Choose from 4 colors at no extra charge.

30" gas range without EverClean oven panels. Reg. 199.95. Sale \$177

Or save on a range with a self cleaning oven.

JCPenney
We know what you're looking for.

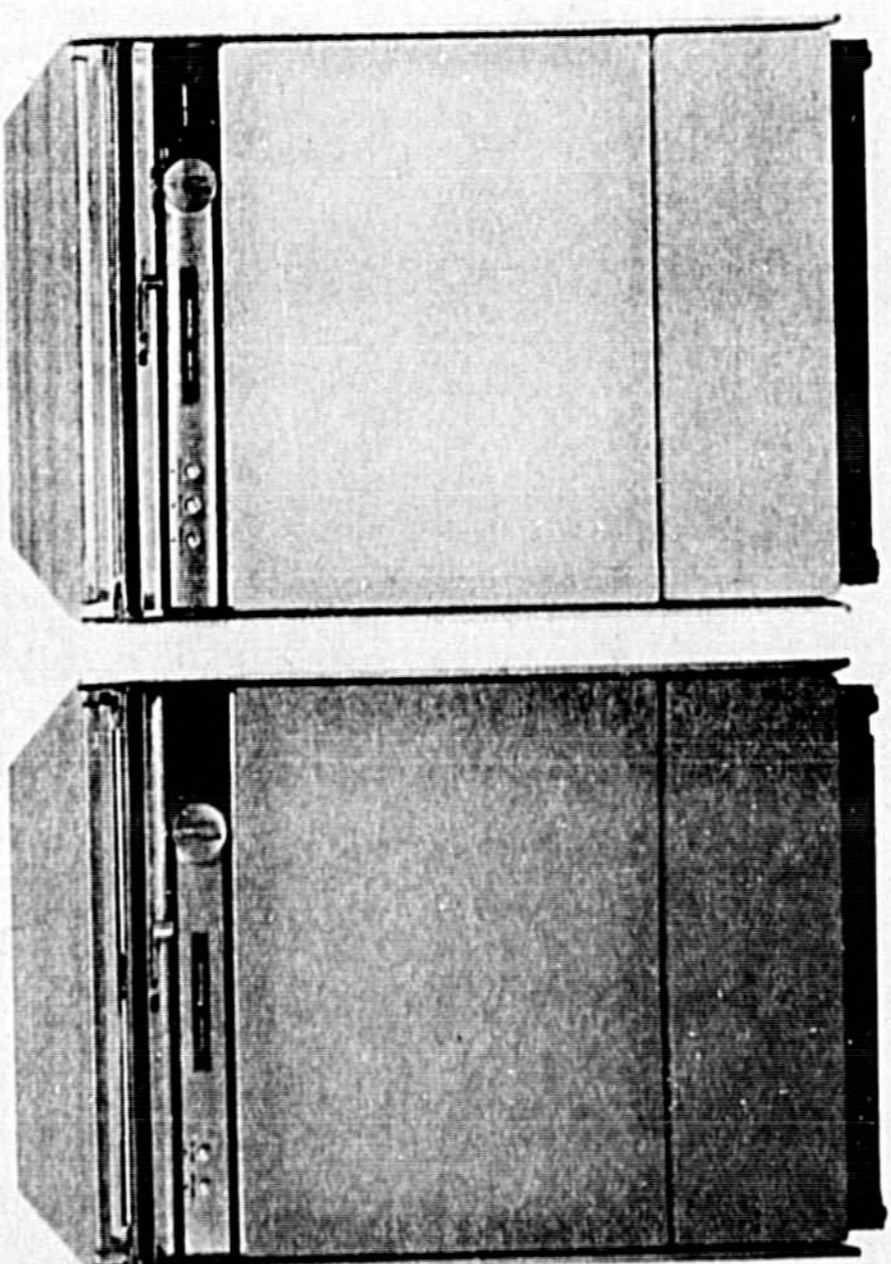

Save 20⁹⁵

Save \$20

Reg. 199.95. Sale \$179. Front loading dishwasher can convert from free-standing to built in. Features 2 wash cycles, 3 spray patterns, and a built-in cutting board top. Dual detergent dispenser, too. Choose from 3 colors at no extra charge.

Sale prices effective thru Saturday. Use the JCPenney Time Payment Plan.

Reg. \$204. Sale \$184. Convertible front loading dishwasher features asbestos padding that minimizes noise. Has 3 wash cycles, maple cutting board top, dual detergent dispenser, and a built-in cutting board top. Choose from 4 colors at no extra charge.

Undercounter dishwasher. Reg. 179.95. Sale \$159

Dishwasher sale! If the savings don't sell you, try a free 10 day home trial. It'll sell itself.

Special! Stereo console with am/fm tuner, phono, tape. Big on sound, not on price.

\$199

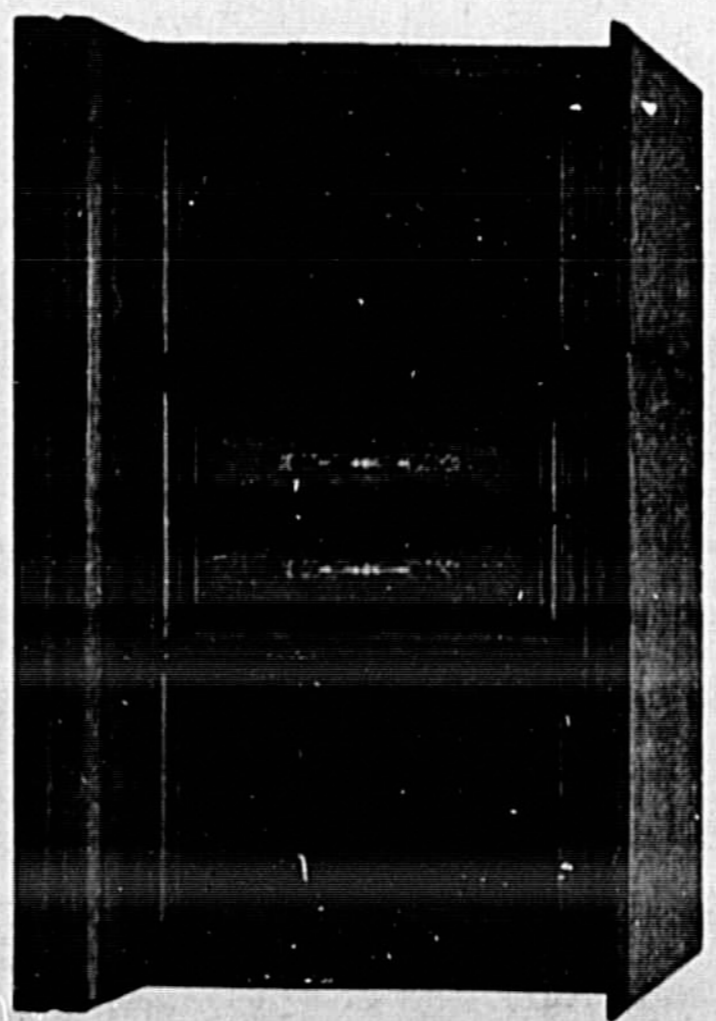

Mediterranean style console stereo. Features a built-in phono, am/fm tuner, console features 4-way speaker system for full dimensional stereo. Solid state chassis, am/fm tuner, 4 speed turntable, 4 speaker operation. Built-in 8 track tape deck plays your favorite stereo cartridges.

Check the low prices on these component systems with tape.

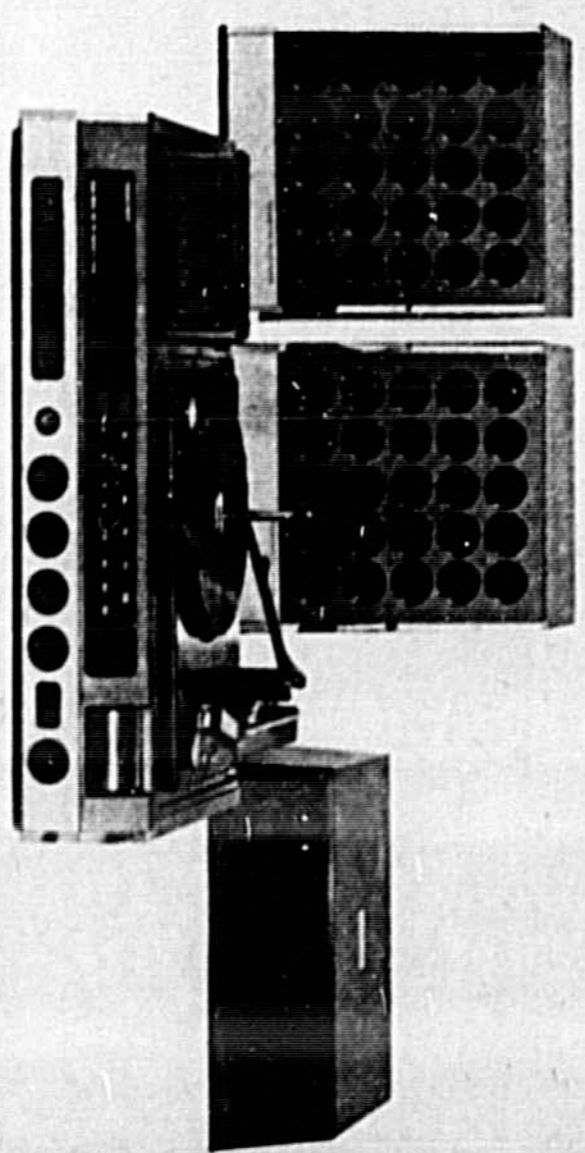

17450

29995

3-pc. radio/ phono stereo component system with 8 track tape player. Solid state chassis, easy to use controls. BSR mini changer with 4 speed turntable. 4 speaker inel and speaker enclosures.

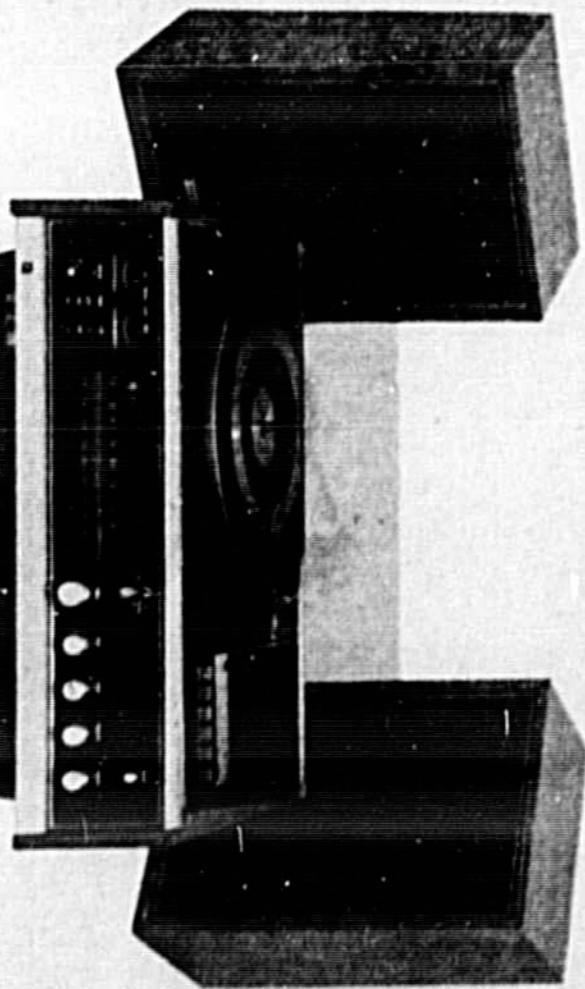

Use the JCPenney Time Payment Plan

JCPenney
We know what you're looking for.

8 belltops combine for latest styling! Machine washable. 29.98
Regular 6.99

Save 1.99

\$5

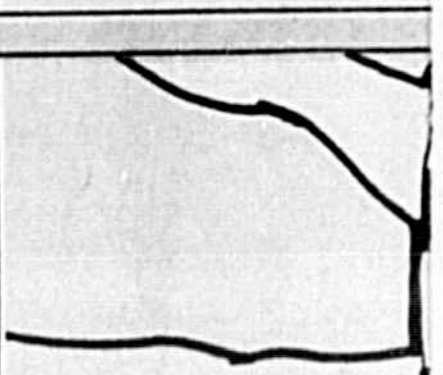

4.00

Save 1.11

contrast trims. Many with inside pockets, zippers. Regular 3.99

Save 99¢

\$3

Sale! Pick up a refrigerator to match your kitchen. We'll pick up the tab for color.

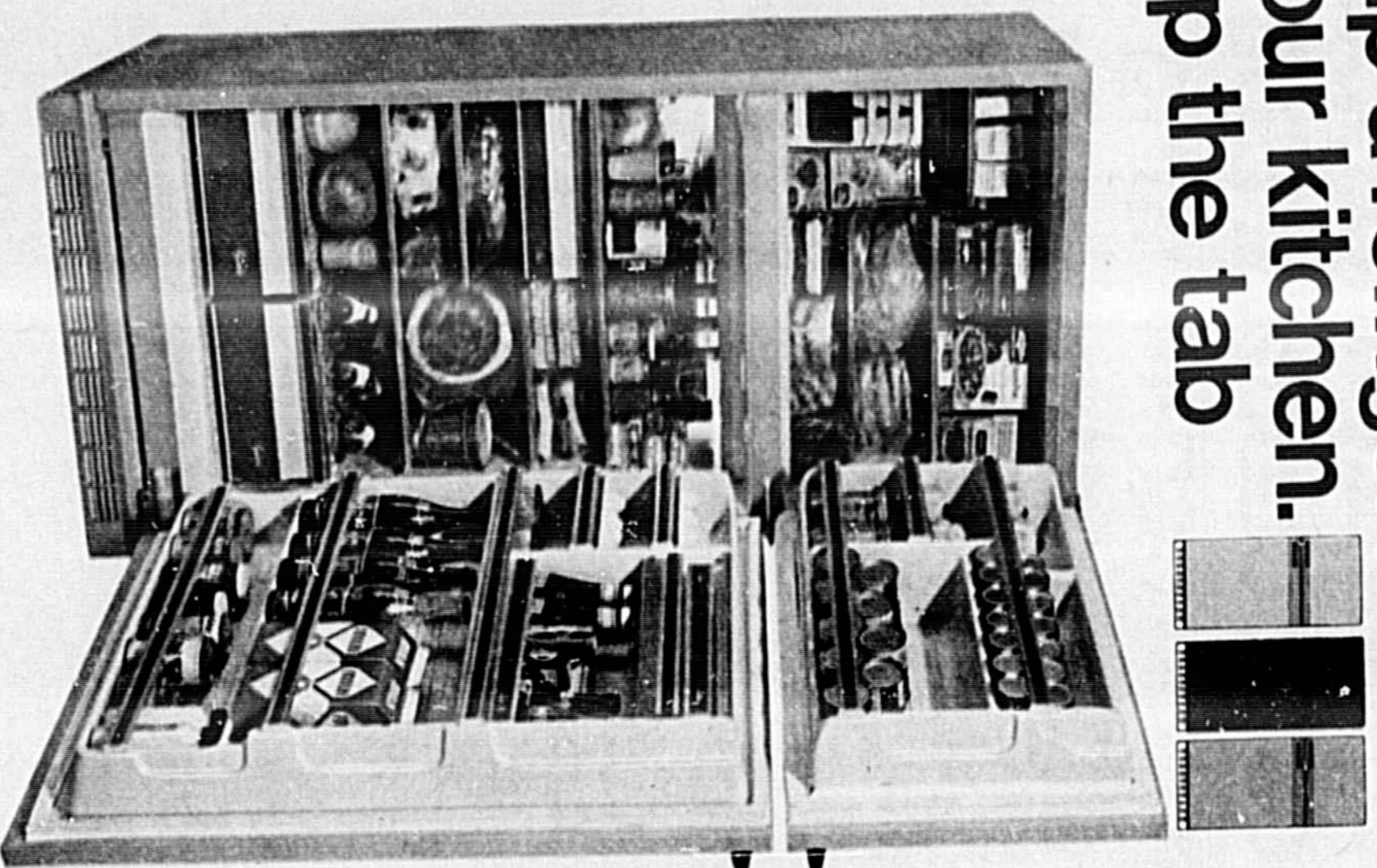

Save 3195

Reg. 3795. Sale \$476. 29 cu. ft. top mount refrigerator and freezer sections. 5 half width shelves adjust for easy storage. Has twin crispers plus meat pan drawer to keep food fresh and longer-cooked so it's easier to clean underneath and on all sides. Choose from 3 popular colors at no extra charge.

Sale prices effective thru Saturday, October 7th. Use the JCPenney Time Payment Plan

Save 3195

Reg. 3495. Sale \$318. 16.7 cu. ft. top mount refrigerator. Freezer is completely frost free and has reversible door. 5 adjustable half width shelves, twin crispers plus meat pan. Choose from 4 colors at no extra charge.

16.6 cu. ft. unit with reversible door. Reg. \$359... Sale \$278

Save 4195

Reg. 4195. Sale \$378. 19.2 cu. ft. side-by-side refrigerator/freezer is completely frost free. Crisper for ripen-older free. Choose from 3 colors at no extra charge.

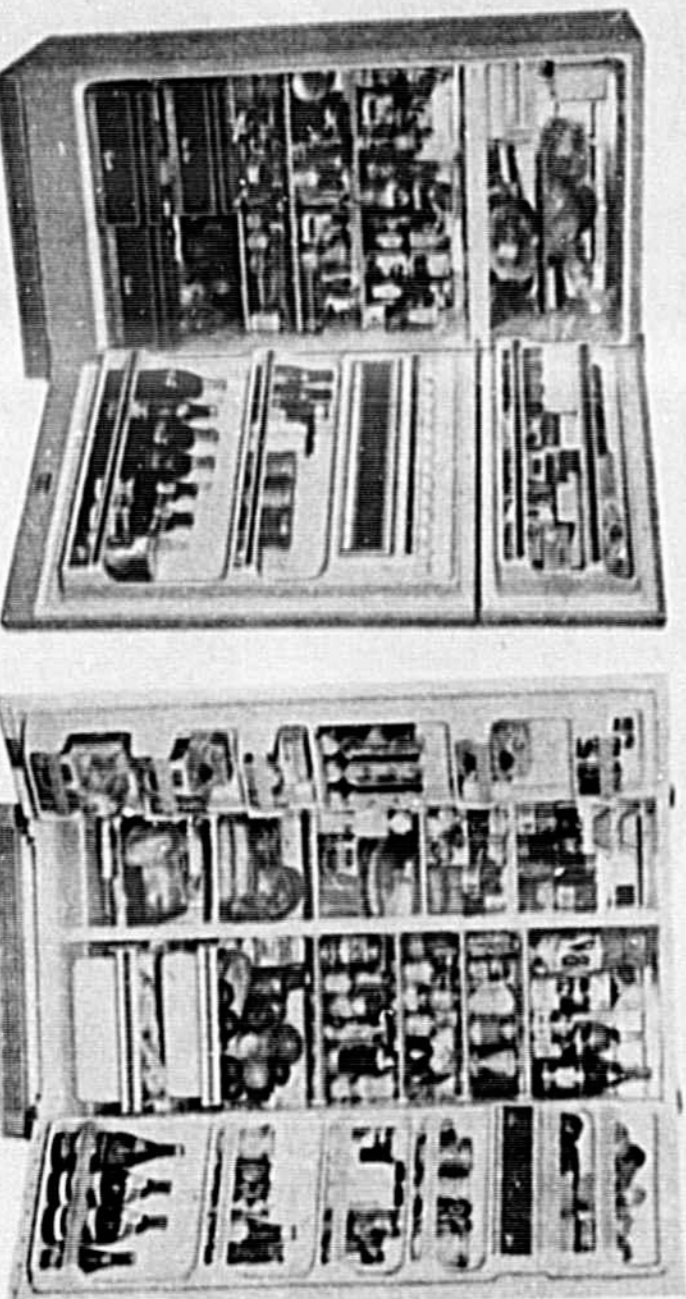

Sale! This week only. Our finest quality Kodel polyester carpeting at big savings.

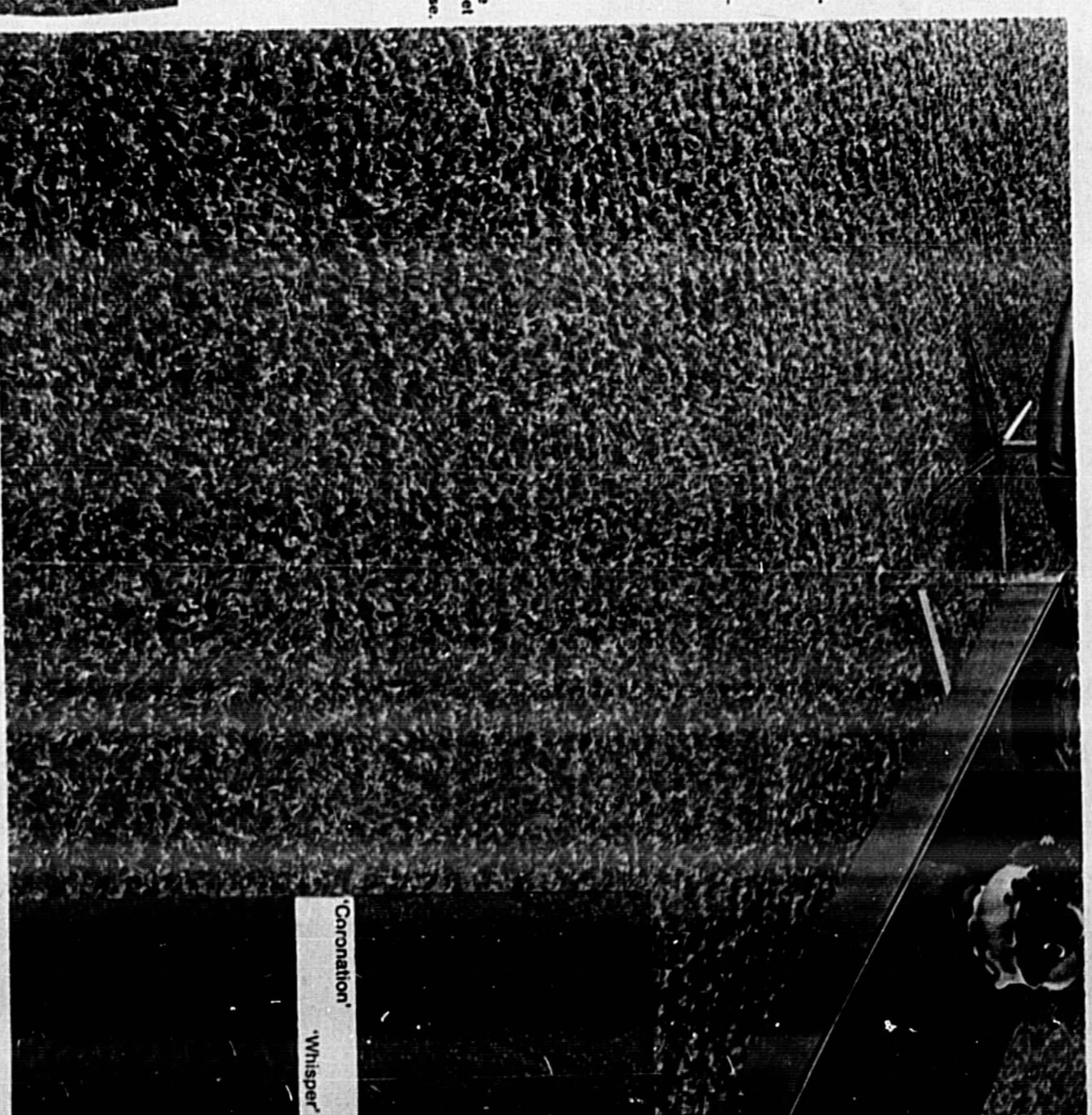

Sale 699

Choose from shag, splash, or random shag. All with a heat set pile that provides lasting bounce back. Resists staining by water, wine, beer, coffee, tea, perfume, hair-tons, linen-tons, and solid fashion colors guarantee great decorating flexibility.

Trident shag Reg. 8.99
Coronation carpeting Reg. 7.99
Whisper splash Reg. 7.99

Come in or use our free at-home service. It's easy to call and we'll come to your home or office. No obligation, of course.

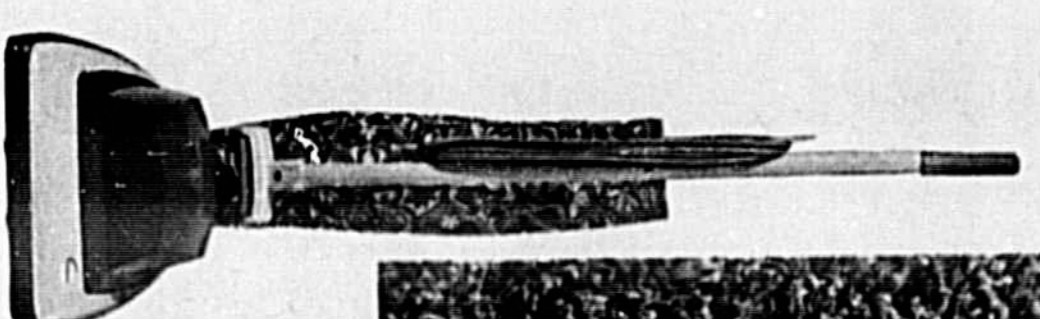

Special 4488

Our upright vacuum cleaner beats, sweeps, and cleans your carpet all at once. 4 height adjustments. 3-position handle. Palsley vinyl bag. Red and white. Sale prices effective through Saturday, October 7, 1972.

Sale! Price

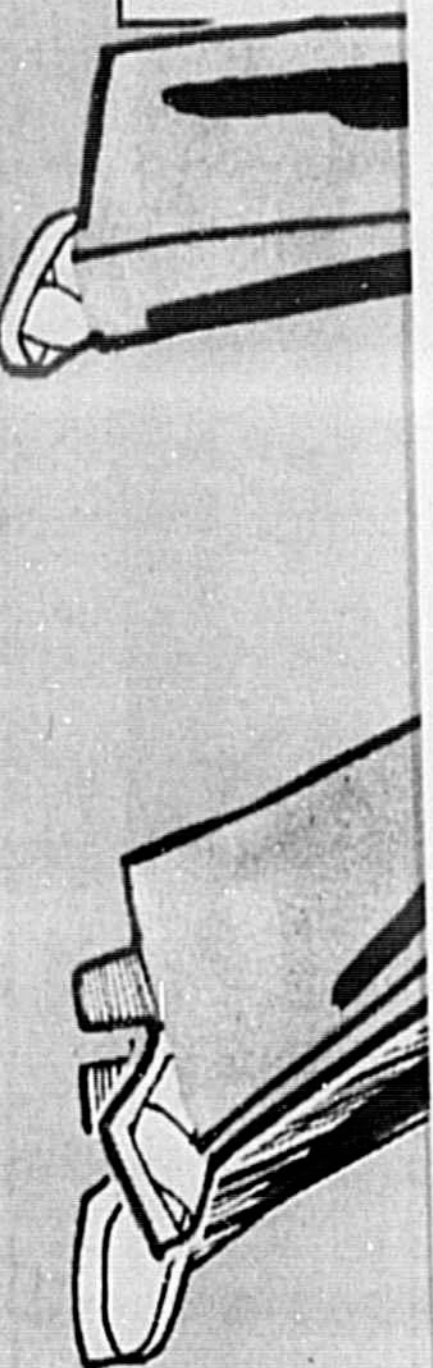

8 ballpoops combine for latest styling! Machine washable. 29-38. Regular 6.99

Save 1.99 **\$5**

4.00
Save 1.11

CONTRAST TRIMS. MERRY WITH INSIDE POCKETS. ZIPPEERS. Regular 3.99
Save 99¢ **\$3**

JFK's Mother Killed Cape Bill

Canaveral Change Measure Blocked By Massachusetts Congressman, Friend Of The Late President

MIAMI (AP) — A personal telephone call from Rose Kennedy to Massachusetts Congressman Thomas O'Neill Jr., apparently helped to kill a bill to change the name of Cape Kennedy back to Cape Canaveral, the Miami Herald said today.

Clark Hoyt of the Herald's Washington Bureau said O'Neill in turn contacted Rep. George P. Miller, D-Calif., chairman of the Science and Astronautics Committee, and asked him to block the name-changing bill.

The measure to rename Cape Kennedy was pushed through

the Senate last July by Florida Sens. Edward Gurney and Lawton Chiles. Cape Canaveral was named Cape Kennedy in 1964 in memory of President John F. Kennedy.

The Herald said Miller could kill the bill by merely failing to put it on his committee's agenda.

"He (Miller) likes Tip

(O'Neill) pretty well, so that pretty well wipes it out," the Herald quoted an unnamed congressional staff member.

An aide to O'Neill confirmed Tuesday that the congressman did go to Miller and stop the bill. As of now, its finished," the Herald said.

But the aide, according to the newspaper, while admitting

that the mother of President Kennedy had phoned O'Neill, denied the Boston-area Democrat was acting on her behalf.

"He is doing this on his own because he was a friend of Jack Kennedy's and doesn't feel that, all of a sudden, we should start changing the names of places named after the late

president," the aide told the Herald.

Florida members of Congress, who say they are acting on the wishes of residents of the area, have been trying for several years to reinstate the name Cape Canaveral, first given to the region more than 400 years ago by Spanish explorers.

The Herald said Rep. Lou Frey, R-Fla., was so incensed Tuesday over the apparent killing of the bill that he threatened to try to change the name of Cape Cod, Mass., to Cape Kennedy.

The Sanford Herald

Wednesday, October 4, 1972—Sanford, Florida 32711
65th Year, No. 32 Price 10 Cents

218,000 Population Seen In 1990

Seminole Fastest Growing County

By FRED VAN PELT

Seminole County is the fastest growing political subdivision like proportions within the United States, according to a report by the East Central Florida Regional Planning Council, released today by its

Oseola-Seminole-Orange committee chairman, Sidney Vihlen Jr., vice chairman of the Seminole County Commission.

Not only is South Seminole County expected to near double in size by 1975, as compared to 1970, but, according to Vihlen, "the south part of the county is becoming saturated (population-wise) and the trend now is shifting to the northern part of the county."

Vihlen elaborated by pointing out that the Greater Sanford area was estimated in April 1972 to have a population of 37,500 and that it is anticipated it will grow to 48,000 in 1975 and 72,000 in 1990.

Vihlen stated: "The Planning Council has been monitoring growth in the region and ... based on housing construction, school enrollment and utility hookups ... it has become apparent that our previously liberal projections should be revised."

He pointed out that presently there are 7,000 homes under construction in the Greater Sanford area alone. To further elaborate on the Sanford area

growth he indicated the proposed 1,200-acre (each) tracts of "Heathrow" and "Greenbelt" - slated for the Interstate 4-Lake Mary Boulevard intersection - as two prime examples of future growth.

The county commissioner recalled that in 1970 the Planning Council predicted Seminole County would grow from the 1970 census count of 83,692 to 98,000 by 1975. The 1975 projection was enlarged last year to an estimated 124,000.

Further, estimates for 1990 were increased from 148,000 to 172,000 while the projection for 1990 is 218,000 persons in Seminole County. Vihlen terms these estimates as "very conservative."

To recap, Vihlen pointed out Seminole as a whole is expected to nearly double from the 1970 census figure of 83,692 to an estimated 1975 population of 150,000 while Greater Sanford is

expected to grow from 37,500 last April to 48,000 in 1975.

Mayor Lawrence Swafford, of Altamonte Springs, only today reported that building permits issued between January and September this year totaled in

Washington, D.C., Auto-Train Corporation said it carried 14,785 automobiles and 47,390 passengers between Lorton, Va., and Sanford in the three months ending July 31, and 5,262 more cars and 18,929

passengers during August.

For the first quarter of its fiscal year, May through July, the company reported unaudited net income of \$12,587 on gross revenues of \$3,103,665.

Auto-Train said a favorable trend continued into the first month of the second quarter, completing the summer season, with net earnings of \$29,039 during August on operating revenues of \$1,201,125.



One Picture Is Worth Population Of 218,000

South Seminole County is reaching the saturation point population-wise, in the opinion of the East Central Florida Regional Planning Council and the population trend will shift northward. Pictured is the SR 436-U.S. 17-92 intersection, with Prairie Lake at center right, Seminole Plaza to the lower left and English Estates at the upper left.

(Bill Vincent aerial photo)



By John A. Spolski

Kudos to the local elections office - AGAIN! Last night's performance in totaling the election results demonstrated the proficiency of Camr Bruce's staff in that this group was the first - the very first to be completed last night, including all others in the entire state!

From The Mailbag:

"Dear Mr. Spolski: "Just when you think you have heard everything about this county, someone comes up with a new one. So, we don't need more people or more industry, just more money than more taxes."

"Well when you are filled up to here - try this one for size, to bring up to date on censorship: From the book, written by Jerry Della Femina titled "From Those Wonderful Folks Who Gave You Pearl Harbor."

"It is about the advertising war, as follows: Page 195. The U. S. Government has decided that you cannot call your cherry pie cherry pie unless it has 32 cherries per pie, or something like that. Now who is going to yell about the cherry PIE? Because one man in Washington has arbitrarily set a figure of cherries per cherry pie, the pie company has come up with a sieve and they've got to be counted and before it can be emptied into the pie they must be no less than thirty-two cherries in the pie.

Yours for better cherry pies.

Let's blame it on George Washington, O.K.? If he hadn't replied that this was his favorite pie, this wouldn't have come about.

Why didn't he say he liked watermelon? They're easier to count, right?

Today is the tomorrow you worried about yesterday - and boy, you were so right!

Seriously, speaking of consumer protection ... my thanks to the Mailbag South Seminole Chamber of Commerce for mailing me a booklet entitled 20 WAYS NOT TO BE GYPPED. And for the record, there are more than 800 known gyps!

The one which particularly caught my attention was No. 18 - Vanity can cost you money or health. "No known product or service can - grow your hair, make you taller; remove or prevent wrinkles; reduce your weight by - massages, creams, belts, girdles or sweat baths; or develop your bust. (Hummum, now lemme see. I've already been sucked-in on four of those.)

C of C Unit Supporting 'Heathrow'

By BILL SCOTT

Endorsements of the Jen Paulucci "Heathrow" development and a state proposed \$240 million general obligation bond issue for the purchase by the state of outdoor recreation lands were actions taken this morning by the Greater Sanford Chamber of Commerce community development committee.

As a companion measure with the bond issue, which is designed to have the state purchase outdoor recreation lands, the Chamber committee asked that the Wekiva River scenic river project be included, since it was explained by Harold Rowland, committee chairman, there are two pieces of land adjacent to the river that could be incorporated in the Wekiva designation as a Scenic River by the state, if funds to purchase were available.

In explaining the support for the Heathrow project, which was sidetracked by the Seminole County Planning and Zoning Commission a month ago after the county planner reported the county is not ready for such a development, the committee approved a motion by Berta Hall calling for support of the project and a request to the County Commission that it favorably consider appropriate zoning to accomplish it.

Whalen Requests Freedom On Writ

By MARION BETHEA

A class action petition for a writ of habeas corpus has been filed by Michael Whalen, who pleaded guilty to the murder of Richard Day and was sentenced to life imprisonment on a guilty plea to robbery, and Robert Ryan, a prison inmate at Starke.

Ryan states that the petition attacks a Florida statute, governing murder, as not being a felony but rather a misdemeanor. Further, he states that the statute, when applicable, he and Whalen could not be punished by death. Further, the petitioner contends Whalen is entitled to a jury trial and vacation of his previous sentence. The petition requests the court order the release of Whalen.

Sale! Pick up a refrigerator to match your kitchen. We'll pick up the tab for color.

Save 3195

Reg. 3795. Sale \$348. 29 cu. ft. top mount refrigerator/freezer is completely frost free and has width shelves, twin crispers plus meat pan. Choose from 4 colors at no extra charge. 16 cu. ft. unit without reversible door. Reg. \$298 ... Sale \$278

Save 3195

Reg. 4195. Sale \$378. 19.2 cu. ft. side-by-side refrigerator/freezer is completely frost free. Crisper and meat pan help keep food fresh and long-odor free. Choose from 3 colors at no extra charge.

Save 4195

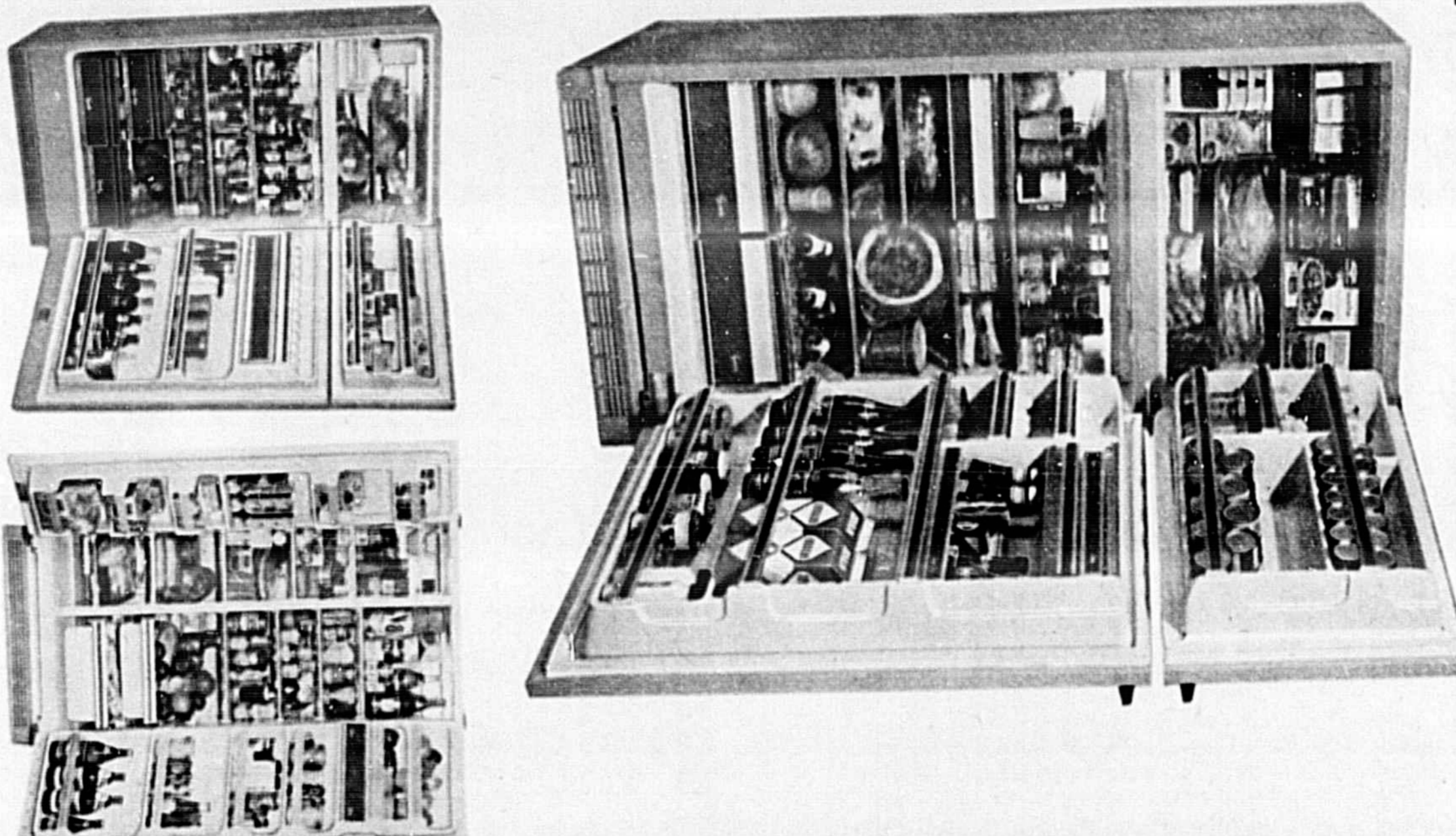

Sale! This week only. Our finest quality Kodol polyester carpeting at big savings.

Save 699

Choose from shag, plush, or random sheared. All with a heat set pile that provides lasting bounce back beauty. Long wear, tonics, three-tones, and solid fashion colors guarantee great decorating flexibility.

Trident shag. Carpeting. Reg. 6.99. Carpeting. Reg. 7.99. Whispur shag. Carpeting. Reg. 7.99

Come in or use our free shop-at-home service. It's easy to call and our carpet salesmen will come to your home. No obligation, of course.

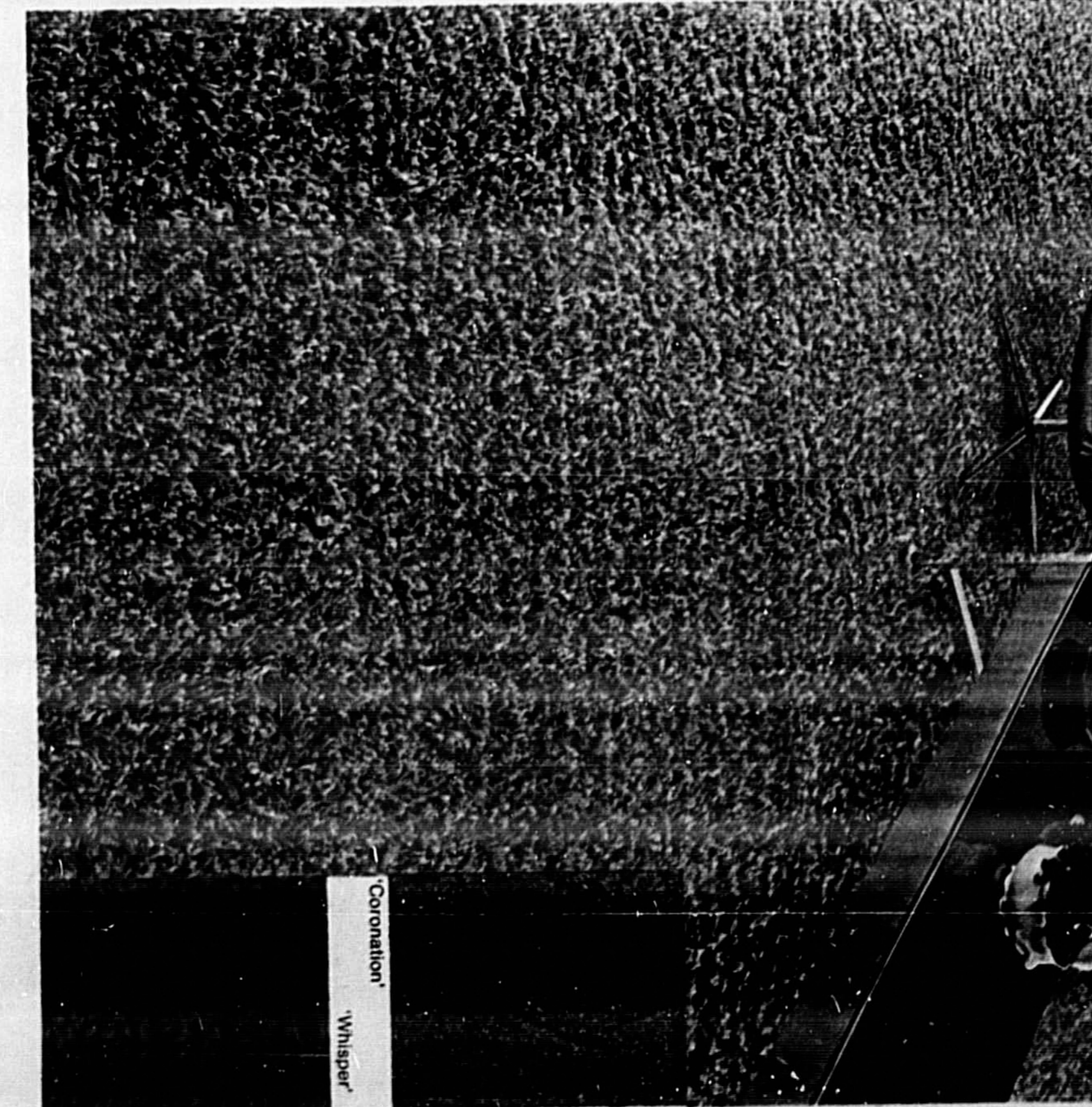

Special 4488

Our upright vacuum cleaner beats, scrubs, and cleans your carpet all at once! 29-38 3 position handle. Heavy duty bag. Red and white. Sale prices effective through Saturday, October 7, 1972.

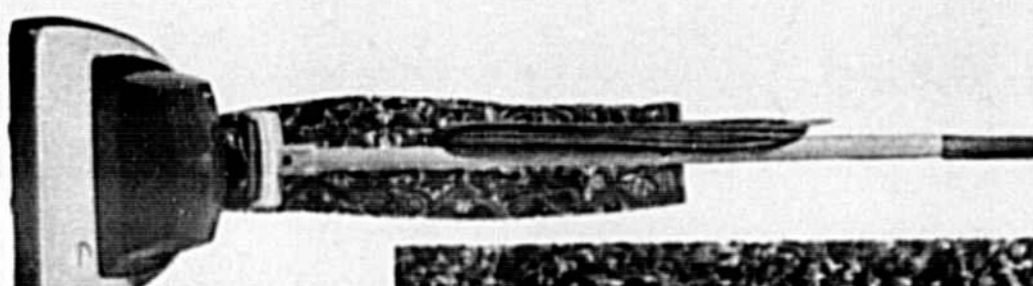

Sale! Price

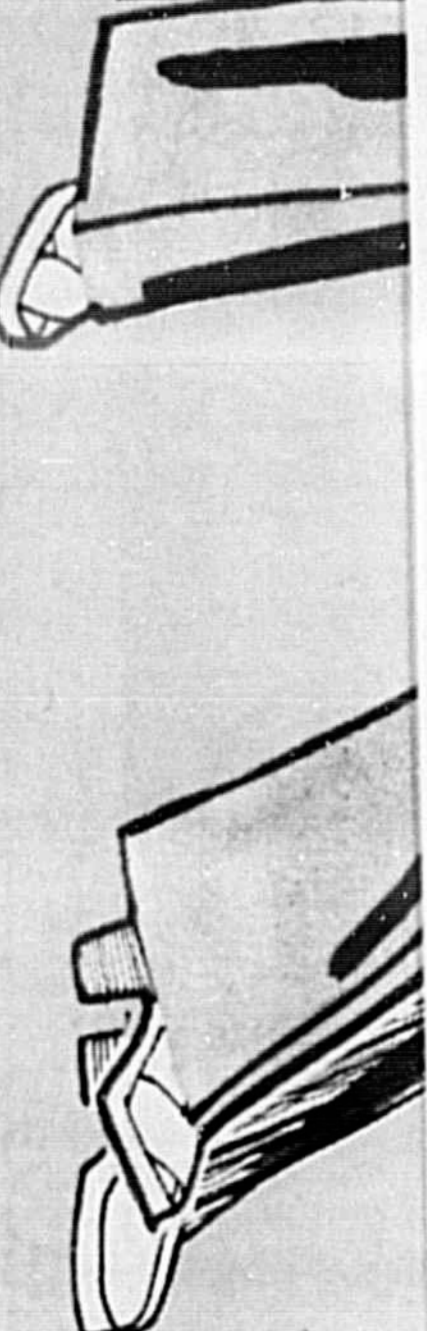

8 bellows combine for latest styling! Machine washable. 29-38 Regular 6.99 Save 1.99

4.00 Save 1.11

CONTAIN TRIMS, METAL INSIDE POCKETS, ZIPPERS. Regular 3.99 Save 99c

3

ALL KINDS OF PANELING

for Creative Homeowners

PRICED FROM \$2.99 up

Paneling Accessories
Prefinished Mouldings

For the ultimate in ceiling luxury visit our Armstrong Ceiling Tile Center where you can see the latest in ideas for beautiful ceilings.

Open 'Til 4 P.M. Saturdays

MASTER CHARGE
BANKAMERICARD

GREGORY LUMBER

520 S. Maple Ave. Sanford, Florida 322-0500

Judge Postpones Turner's Trial

By PAT LEISSNER
CLEARWATER, Fla. (AP) — Circuit Court Judge William A. Patterson citing a circus-like atmosphere "calculated to influence and intimidate jurors," today postponed the trial of mink oil tycoon Glenn W. Turner, accused of violating the state's securities laws.

(Earlier story, Page 8A)

Earlier 600 women, some carrying placards, paraded outside the Pinellas County Courthouse, jamming the entrance, until asked to move by Police Chief Frank Daniels. The women, headed by Mrs. Rosemary Montgomery, 25, said they were demonstrating their love to Turner.

Judge Patterson postponed the trial until Monday after Chief Judge B. J. Driver issued an order saying the court considered the "great crowds of

Index

Area deaths	1B
Bridge	7A
Calendar	2A
Classified ads	4B-5B
Comics	4B
Crossword puzzle	7A
De Crane	4B
Dear Abby	7A
Editorial comment	4A
Entertainment	7A
Horoscope	3A
Hospital notes	7A
Public notices	2A
Society	6A
Sports	2B-3B
Stocks	3A

Nixon Has Plans, Too
McGovern: Can End War

By R. GREGORY NOKES
Associated Press Writer
Sen. George McGovern will announce on Oct. 10 a plan to end the Indochina war, he campaign aides say. It will be part of an intensive antiwar campaign by his supporters during the Columbus Day weekend.

McGovern "will tell America what Richard Nixon cannot tell you to vote against your own interests—to slash your own throats to vote against the labor movement," he said.

President Nixon has not scheduled any campaign appearances this week. Vice President Agnew campaigned for the ticket in Indiana and Montana. He planned to go today to South Dakota, McGovern's home state, and to Nebraska.

In Great Falls, he praised the administration's initiatives in farm exports, saying they meant "cash in the pockets of American farmers." He also said the Democratic Congress has acted on only six of 31 administration proposals on the environment.

The Nixon campaign organization Tuesday began dispatching 9.3 million letters to lists of voters in California, New Jersey, Illinois and Pennsylvania. A spokesman said the goal is to increase the Nixon vote by 2 per cent over what it would otherwise be.

American Party presidential candidate John Schmitz said in Atlanta, Ga., Tuesday his party will be listed on the ballots in at least 32 states and he has an "excellent" chance of winning in California, Michigan and Wisconsin.

The California congressman predicted the voters will turn to the American party in four years. "If Richard Nixon is re-elected, things are going to get so bad that people are going to remember who told them the truth in the first place," he said.

Weather

Yesterday's high 85 low 72. Considerable cloudiness through Thursday with showers most likely during the afternoon and evening hours.