

Water Quality Bill Near OK

WASHINGTON (AP) — By near unanimous vote, Congress has sent President Nixon a \$24.6-billion antipollution bill which aims to purify the nation's waters by 1985.

The three-year authorization measure must be backed up with appropriations.

Final passage in both houses came within three hours Wednesday evening. The House passed the bill 366 to 11 and the Senate followed with a 74-0 vote.

If fully financed, the water-quality bill would provide \$9.7 billion in fiscal year 1973, \$9.95 billion in 1974 and \$7.65 billion in 1975.

It would allot \$336 million for the current year for waste-treatment works already authorized.

Other facets of the bill include: —A requirement that industries discharging waste into waters apply the best practicable control technology by July 1, 1977 and the best available by July 1, 1983. —\$18 billion in grants to municipalities to build waste-treatment plants and improve sewage collection. The federal government would pay 75 per cent of the cost of building waste-treatment plants.

Continuance of current water-quality standards plus limits on how many effluents a plant may pour into the nation's waters.

—Required government approval of state guidelines for issuance of permits for disposing effluents.

—Administration by the Army Corps of Engineers of a separate permit program for disposal of dredge and fill material in certain areas.

...While In Seminole County

On the local level, the second of three meetings was held yesterday at the First Federal Savings and Loan Association building in Altamonte Springs, expressly for Seminole County municipalities.

An earlier meeting involving Osceola County had 100 per cent representation. Tomorrow, the municipalities from Orange County will hold their meeting of the Orange-Seminole-Osceola water quality management study committee.

This program design study has a fixed cost of \$350,000 and covers the period following for the next 18 months.

Although all six Seminole municipalities received written invitations including each of their five elected officials and/or their representatives, out of a possible total of 30 persons only three persons attended representing Oviedo and Sanford. Sanford City Commissioner A. A. Clamham, City Manager Warren Knowles and newly elected Oviedo Councilman Arthur Evans.

There was no representation from Altamonte Springs, Casselberry, Longwood or Winter Springs.

Sewer Ban Hits Economy

Swafford Predicts

By DONNA ESTES

LONGWOOD — Financial disaster for families of construction workers with severe damage to the economy of the entire state was predicted by Altamonte Springs Mayor Lawrence Swafford in the Oct. 1 moratorium on sewer system connections throughout Florida.

Swafford, in discussing the moratorium on new construction sewer connections to systems considered inadequate, said the \$1 billion annual construction industry is the largest employer in the state at this time.

He continued that in short order, with the moratorium, thousands of workers will be jobless and unable to pay house payments, car payments, medical expenses and all the other necessities of life.

Swafford interpreted the action as a way of putting pressure on the federal government to give two-thirds grants to pay costs of updating sewer treatment. "Good will come from this," he said.

As for his city, he said the sewer treatment plant cited by the state-Spring Valley-is operating at 90 per cent capacity, and plans are to update it by adding new machinery, pumps, etc. "But we are not about to close the plant," he declared. He pointed out the Spring Valley facility, recently acquired by the city, has a 100,000-gallon daily capacity.

The West Altamonte (San Sebastian) facility will be full before the city goes to construction on increasing capacity at the main sewer plant from 1.2 million gallons to 3.2 million gallons daily.

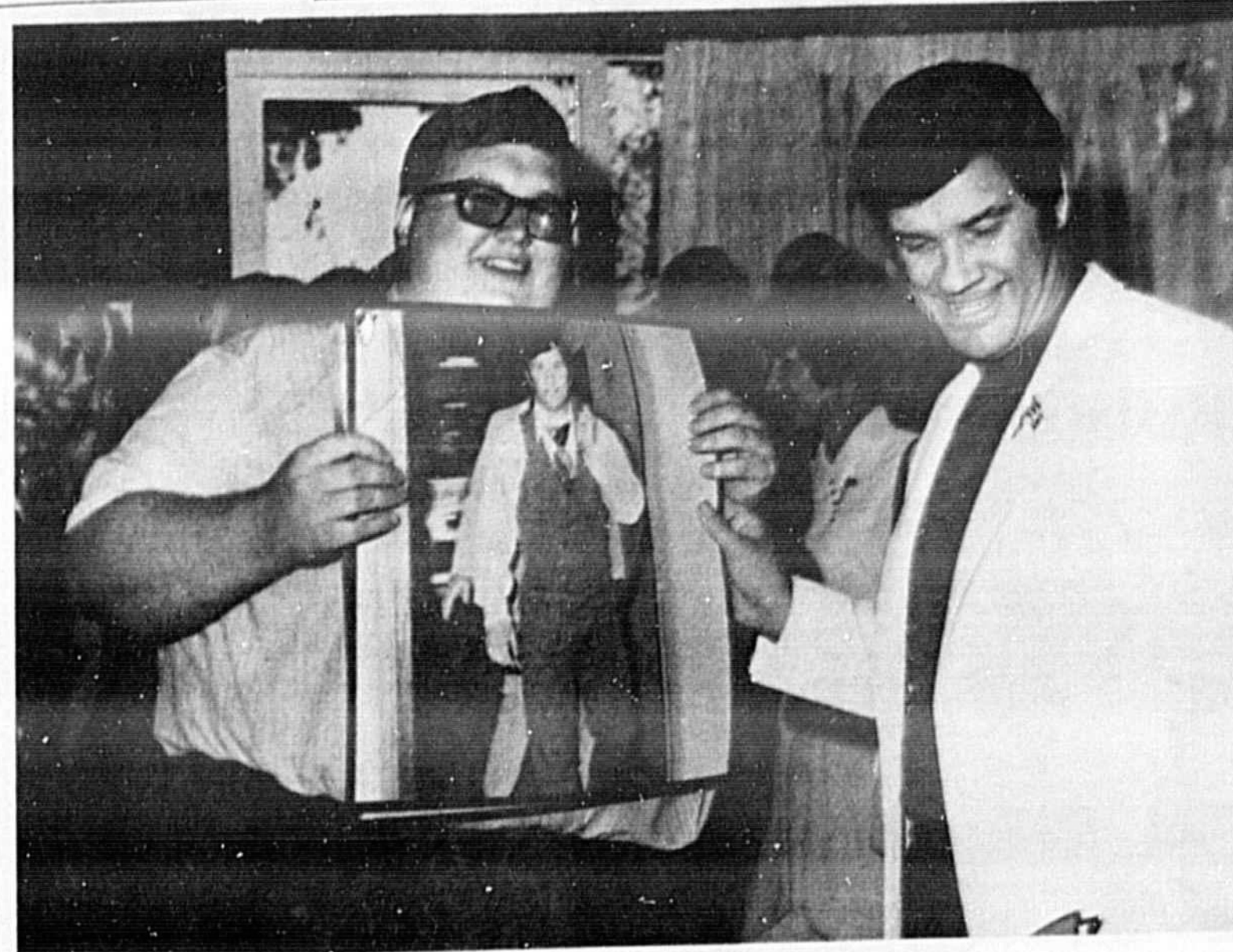

PORTENT OF THINGS TO COME

It was humorous when this photograph was snapped last Sunday as Millionaire Glenn Turner entertained the news media at his castle. Herald staffer Gary Taylor presented a blow-up of his photograph showing Turner leaving the Seminole County jail a couple weeks ago after posting bail to answer Pinellas County criminal charges. Another Taylor photo snapped of Turner leaving the jail appeared in Associated Press newspapers throughout the United States and the military Stars & Stripes in Germany. But it wasn't funny today. Turner's attorneys are in the District Court of Appeal at Lakeland appealing a 150-day jail sentence for contempt meted to Turner.

'Mystery Man' In Turner Case

By BILL SCOTT

Wednesday visits by a mystery man to two former Glenn Turner officials' homes to "talk" over the coming trial of Turner on 86 counts of violating Florida's securities laws has prompted a third former Turner Enterprises official to contact Seminole County authorities.

Seminole Deputy David Zorian answered a call last night to the home of Ronald Hallman, 1805 Briarcliff Road, Altamonte Springs, Turner Enterprises assistant controller, who resigned his office, along with Antonio Lopez, Turner controller, and William Nusbbaum, assistant treasurer, both of Winter Park. Hallman told Zorian that Nusbbaum and Lopez had received visits from a man who would not identify himself but who wanted to learn what form of testimony they would give in the Turner trial.

The deputy advised The Herald that Hallman told "me all he had to do is 'truth' to get Turner off."

Zorian in his report listed the tag number of the car driven by the man calling on Nusbbaum and Lopez as 12W-2898, which was copied by one of the men and relayed to Hallman, who, in turn, gave the number to Zorian.

Today, to whom the license was issued and was informed it was out of Lake County and belonged to a car owned by the State Bureau of Motor Vehicles.

In checking with the State office at Tallahassee, this newspaper was informed by a department employee that the file listing the car is "missing" and she would have to hunt for it. The employee promised to return the call when the information was found.

Zorian, in his report, said Hallman was "scared of threats" and advised he was one of three persons having to testify against Turner when his Pinellas County trial is finally underway.

Content of court charges against Hallman and Lopez were dropped by Pinellas officials, Mrs. Nusbbaum said she did not want to talk about the alleged threats made to her husband and Lopez were reported at Fort Lauderdale. Deputy Zorian reported he told Hallman to contact the sheriff's office in case someone came to his house and "tried to give him a hard time."

Who wanted to question the men about Turner's Dare to be Great organization.

This morning Hallman, contacted by The Herald, said he was advised by the Pinellas County state attorney to "get in touch" with local authorities and advise them of the visits of the "mystery man" to Lopez and Nusbbaum.

Nusbbaum and Lopez were not available when The Herald tried to contact them.

Mrs. Nusbbaum said she did not want to talk about the alleged threats made to her husband and Lopez were reported at Fort Lauderdale. Deputy Zorian reported he told Hallman to contact the sheriff's office in case someone came to his house and "tried to give him a hard time."

Tycoon Appeals Jail Sentence

By PAT LEISNER
Associated Press Writer

LAKELAND, Fla. (AP) — A three-judge appeals panel took testimony today on whether to set bond for businessman Glenn Turner in a Pinellas County contempt conviction.

The state argued before the 2nd District Court of Appeal that the defense motion to set bond was "frivolous."

["Earlier Story, Page 3A"]

Turner was sentenced to 150 days in jail without bond Wednesday by Circuit Judge William A. Patterson in Clearwater, who held him in contempt for refusing to testify about a demonstration by 600 women just before Turner's securities violation trial was to begin.

"What action was committed in front of Judge Patterson?" asked McNulty, who said it was arguable whether simple refusal to testify constituted contempt.

The prosecutor answered that he could not argue outside the bounds of the written order but that transcript of the entire contempt hearing would be delivered to the court.

McNulty Wednesday night freed Turner on a temporary bond of \$2,000 pending the outcome of the appeal.

The three judges retired to deliberate the appeal and said they would issue a written order in the case.

Turner spent five hours in jail after refusing to testify about the disturbance outside the Pinellas County Courthouse.

When he handed down the contempt citation, Judge Patterson commented, "I'm not going to preside in a zoo."

75 NEW VW's IN STOCK

15 Demonstrators Must Be Sold!

Every Model Available in Stock For Immediate Delivery

only **\$1999**

We Trade For CARS, TRUCKS, BOATS, CYCLES, RECREATIONAL VEHICLES

Bill Baker Volkswagen, Inc.

3219 Hwy. 17-28 South
Sanford, Fla. 32783
Orlando, Fla. 32816

The Sanford Herald

Thursday, October 5, 1972—Sanford, Florida 32771
65th Year, No. 33 Price 10 Cents

'Internationalism' Extolled By McG.

By R. GREGORY NOKES
Associated Press Writer

Sen. George McGovern spoke today of a "new internationalism" to supplant President Nixon's foreign policy which he described as "unconscious isolationism."

But while Democratic presidential candidate McGovern was giving his first detailed account of his foreign policy plans, Vice President Spiro T. Agnew strongly denounced him.

"Nobody can believe George McGovern," Agnew said, adding that the McGovern's policies only "make him very popular in some segments of North Vietnam."

At appearances in South Dakota Wednesday, Agnew said McGovern is "stirring the suspicions of people around the land and relying solely on a campaign of fear and innuendo."

McGovern, in a speech for the City Club of Cleveland today, said the Nixon foreign policies are isolating the United States from allies and trading partners.

"We are isolated from reality by the insistence that tough talk and big Pentagon budgets are somehow synonymous with national manhood," he said.

He urged rejection of "this unconscious isolationism in favor of a new internationalism based not only upon our vital interests, but also upon the kind of nation we can and should be."

The Democratic vice presidential candidate, Sargent Shriver, expressed support in Denver for a decision of the Colorado Labor Council to endorse McGovern against the wishes of AFL-CIO President George Meany.

"If any labor leader, no matter how high he is," Shriver told the council, "tells you to vote for Richard Nixon he is telling you to vote against your own best interests and against the best interests of every worker in the country."

Shriver was to fly to San Jose and Los Angeles today.

Meanwhile, an internal confrontation was building up within the AFL-CIO over Meany's orders to state groups to repeal resolutions urging defeat of Nixon.

He has issued such an order to the state AFL-CIO in California and Oklahoma, and similar orders were expected in Minnesota, North Carolina, Nebraska, Iowa and Texas, where the state labor conventions have called for defeat of Nixon.

Meany Fighting Own Labor Units

By NEIL GILBRIDE
AP Labor Writer

WASHINGTON (AP) — AFL-CIO President George Meany is steaming toward a confrontation with state labor units smarting at his orders to repeal resolutions urging the defeat of Richard Nixon.

Meany reportedly has ordered a half-dozen or more state labor councils to abandon "dump Nixon" campaigns on grounds that such efforts violate the national federation's policy of neutrality in the presidential campaign.

"I don't have the authority to rescind the resolution. I'm going to work on it but we are busy trying to elect a U.S. senator down here and if I can find time, I'll do it," grumbled Oklahoma AFL-CIO President Henry L. Likes in a telephone interview.

"It's incredible," said a staff member of another state AFL-CIO council that has urged defeat of Nixon. "Everything Meany does is neutral in behalf of Nixon."

And while we're on this beat... a Medco Discount Drugs will open in Sanford about November 1st, according to Gene Campbell and Bill Williams of that company. It will be located in the Pinecrest Center on Highway 1-92 at 27th Street, next door to A&P — WEO.

Food Prices Spiral Again

WASHINGTON (AP) — Prices of a broad range of wholesale food, industrial raw materials and manufactured products rose an average of three-tenths of one per cent last month, the government today.

The report by the Bureau of Labor Statistics said the increase included a rise of six-tenths of one per cent for farm products, processed foods and feeds, while industrial commodities increased two-tenths of one per cent.

The report said that in the past three months, wholesale prices rose at an annual rate of 6.7 per cent compared with 4.9 per cent in the first and second quarters of the year, and at an annual rate of 17.4 per cent in the third quarter.

In the 13 months so far of President Nixon's wage-price controls, wholesale prices have risen at an annual rate of 4.3 per cent, compared with a rate of 5.2 per cent in the nine months prior to the controls.

The September increase brought the government's Wholesale Price Index up to 120.2 of its 1967 base of 100. This means it cost wholesalers \$120.20 last month on the average for goods worth \$100 five years ago.

EveryDayLowPrice

CENTER CUT

SIRLOIN STEAKS

U.S. CHOICE

\$1.29

LB

EveryDayLowPrice

FULL CUT

BONELESS ROUND STEAK

U.S. CHOICE

\$1.19

LB

EveryDayLowPrice

FLORIDA GRADE 'A'

FRESH FRYERS

WHOLE 2 PER BAG

3.33

LB

EveryDayLowPrice

CENTER CUT

CHUCK ROAST

U.S. CHOICE

68

LB

EveryDayLowPrice

U.S. CHOICE

CHUCK STEAK

79

LB

EveryDayLowPrice

FREZZER

QUEEN DINNERS

2 LB PKG

98

¢

EveryDayLowPrice

AGARS

Canned HAMS

BONELESS, ALL MEAT, NO WASTE

3 LB CAN

\$2.99

EveryDayLowPrice

LEAN TENDER

GROUNDED BEEF

3 LBS & OVER

59

¢

EveryDayLowPrice

WISCONSIN FULL

CHEESE

79

¢

EveryDayLowPrice

LENN MEATY

FRESH PORK BUTTS

4 TO 8 LBS

65

¢

EveryDayLowPrice

HEAT AND SERVE

FRIED FISH STICKS

1 LB BOX

49

¢

EveryDayLowPrice

PAINTERS PRIDE

BABY POWDER

1 LB PKG

49

¢

EveryDayLowPrice

PAINTERS PRIDE

BABY OIL

1 LB PKG

67

¢

6C-81
Tlan but impo...
Lato establ...
Gh who...
Lah quest...
Peru to re...
For the i...
dent conti...
ity w regai...
caust night...
By tury, came...
value culti...
land. Helat...
Amer came...
spud. Helat...
its on Louis...
tinent royal...
in Fr creati...
baute. The...
than f even...
ly tedical...
main shown...
and g nearly...
dabo. One...
potato sumbe...
ain it mple...
popula centur...
sliced on an...
ated i sd will...
polate...
somed ed s...
erbs. This...
s with al...
owl. One...
at is ionable...
known usually...
sists m and...
w ach. One...
Cre Ma...
Fresh...
This to 12...
I car ham...
1/2 high...
chee...
table...
1/4 cut...
relis...
1 table...
into...
turn hi...
stret to...
greed ch...
in the...
filling...
about 2...
SUN...
Fish C...
H...
H SO...
An a...
desse...
3 cups...
3/4 cuj...
1 cup b...
1 cup...
Filling...
low...
togeth...
butler...
until ti...
Stir in...
mix w...
dough...
into 7...
part it...
lightly...
a 9-in...
we have...
comple...
and one...
out work...
for the...
other????

U.S.D.A. FOOD STAMP COUPONS

we are pleased to accept

Jailer Testifies For State Meat Cleaver Case Near Jury

By MARION BETHA

The "meat cleaver" murder trial of Stanley DeBose, charged in the bludgeoning death of Vera Lee Mathis reached a climax this morning with the testimony of a jailer with the Sanford police department.

James Harkness testified that DeBose made a telephone call at approximately 2:10 a.m. on Aug. 8 and was overheard to remark, "I won't be there tonight. I'm in jail. I just killed somebody."

Defense Attorney Ned Julian Jr. attempted to dispute the statement by asking the witness if possibly DeBose said he had been advised he killed someone but Harkness remained adamant.

Defendant Sleeps During His Trial

By MARION BETHA

Assistant State Attorney Newman Brock, preceding the murder trial of Stanley DeBose this morning, requested Circuit Judge Richard Muldrew hold the defendant in contempt if he fell asleep during the trial.

DeBose, whose defense tactics have sent the jury yawning in and out for profers by the state, and whose tactics Assistant State Attorney Newman Brock has alluded to as "obnoxious," made a point of the fact that DeBose was in

Defendant Sleeps During His Trial

cache of assorted prescription pills. DeBose shared his cell with several other inmates of the county jail.

Duval Elects Blind Judge

By F. T. MACFEELY

Representatives of the Duval County Court is blind.

Reynolds, who is blind, was elected to the Duval County Court by the voters of Duval County in a recent election.

Ex-POW Loyal To Country

By MONTGOMERY, Ala. (AP)

Issues concerning the Vietnam war and prisoners of war are dealt with by the U.S. government, says a newly freed POW.

Major Edward Elias, one of the three POWs released by North Vietnam, said Wednesday that matters involving war and captive servicemen should be handled "government to government and not between diverse groups of individuals."

Bulletin In the News

Circuit Judge Clarence T. Johnson has dismissed a complaint filed in April by Mrs. June Lorman against the city of Longwood questioning the legality of annexation of a tract west of the city of SR 67.

The judge did not determine the merits of the matter, but ruled the proper action would be under a "quo warranto" proceeding. He gave the plaintiff 20 days in which to amend her complaint.

Wives Told How To Act In Public

By JANET STAHR

Associated Press Writer WASHINGTON (AP)—The National Republican Congressional Committee has some advice for candidates' wives: Watch your cigarettes, lay off the gun and never look bored.

To women whose husbands are running for the House of Representatives the manual suggests: "Never talk loud, or argue about your husband or his political positions with anyone."

When sitting on a stage, or at the head table, either cross your ankles or keep your knees together.

When your husband is speaking, watch him proudly. Never appear bored, even if you have heard the same speech repeatedly.

Such admonishments ran through the Capitol Hill chapter of the Women's Political Caucus which takes on the Wives' Manual in this month's newsletter, "Equal Times."

Featured on the cover of the Wives' Manual is a beribboned girl elephant wearing a smile, red lipstick and a pants suit.

NEWS DIGEST

SEN. GEORGE MCGOVERN, the Democratic presidential nominee, says President Nixon's foreign policy is one of "unconscious isolationism," and declares that if elected he would replace it with what he calls a new internationalism for the 1970s.

AFL-CIO PRESIDENT GEORGE MEANY is streaming toward a confrontation with state labor units smarting at his orders to repeal resolutions urging defeat of President Nixon.

FOR THE THIRD TIME Congress has overridden a veto by President Nixon. A bill raising pensions for retired railroad workers will become law without Nixon's signature.

THE CONTROVERSIAL F 111 fighter-bombers return to combat but fly only a few missions.

SCIENTISTS FROM 10 COUNTRIES meet today to discuss future use of a substance called BCG, which is being evaluated as a possible treatment for cancer.

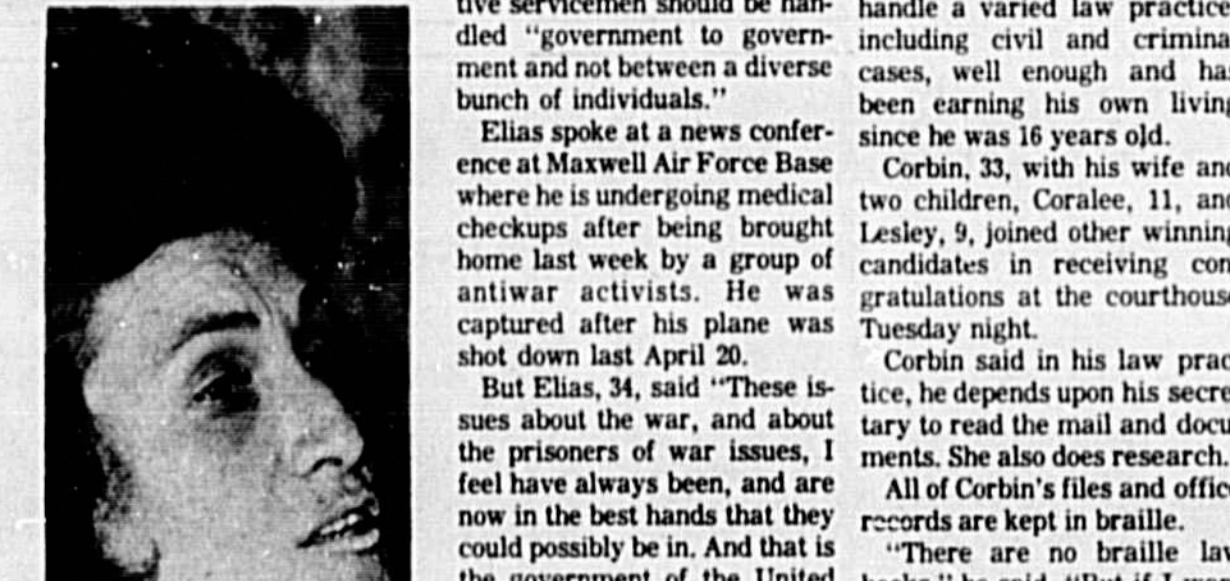

THREE U.S. PILOTS released. U.S. Air Force Lt. Col. James D. Heren, Brookings, S.D.; and Capt. James O. O'Neil, Las Vegas, Nev. Kennedy said he was told the five are in prisoner-of-war camps.

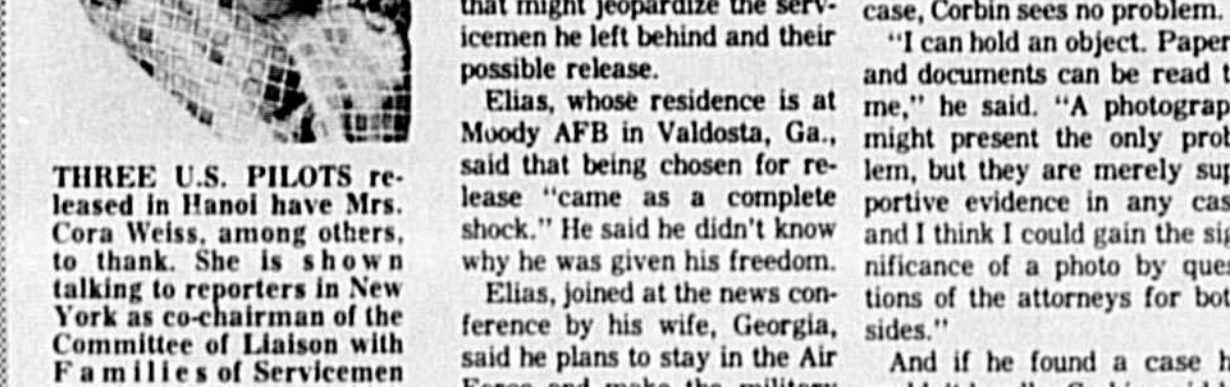

'Paper Bag' Bandit Hits Sobiks Shop. A robber using a paper sack over his head for a mask last night took an undisclosed amount of cash from the operators of a Sobik's Sandwich Shop, French Avenue in Sanford.



Area Deaths. Harold Decker, 83, of 1340 Worthington Ave. Maitland, died Tuesday night at Lakewood Nursing Center.

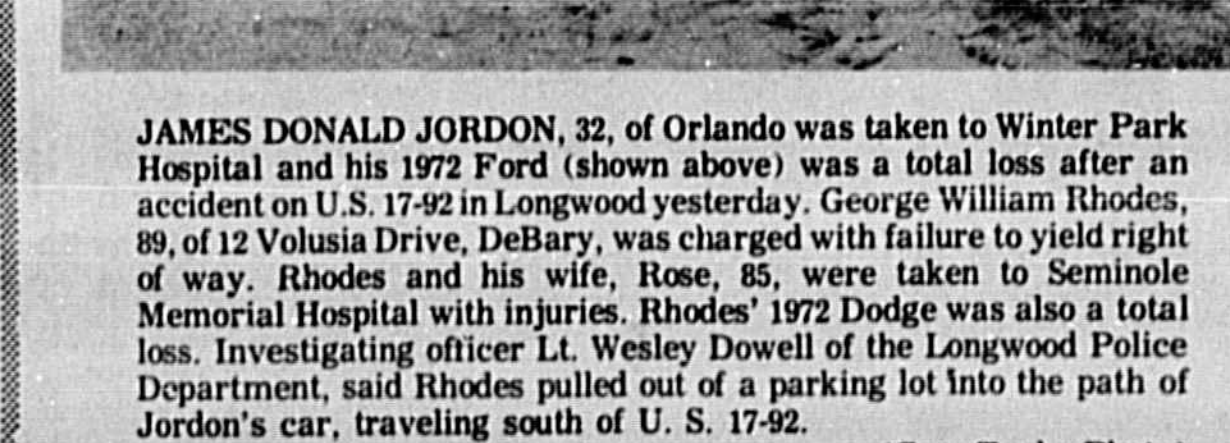

Area Deaths. Harold Decker, 83, of 1340 Worthington Ave. Maitland, died Tuesday night at Lakewood Nursing Center.

F-111 Fighters Back In Action

By GEORGE ESPER

Associated Press Writer SAIGON (AP)—The U.S. Command gave its controversial F-111 fighter-bombers a clean bill of health today after six days of tests and sent them on missions over North Vietnam.

The command reported that the F-111s attacked an air defense center one mile south of Dien Bien Phu and a railroad siding on the northwest line between Hanoi and China.

Floridian Is Listed As POW

By WASHINGTON (AP)—Sen. Edward Kennedy, D-Mass., says the North Vietnamese have supplied him with the names of five U.S. airmen being held as prisoners who were listed as missing in action by the Pentagon.

The five names released by Kennedy are: Lt. Cmdr. Dale V. Raebel, Orange Park, Fla.; Lt. J.G. David A. Everett, St. Simons Island, Ga.; Lt. Cmdr. Theodore W. Triebel, San Diego, Calif.; Capt. Jerome D. Heren, Brookings, S.D.; and Capt. James O. O'Neil, Las Vegas, Nev.

Bungling Bank Robber Gets 30 Years In Jail

JACKSONVILLE, Fla. (AP)—A young man who bungled a bank robbery at Mount Dora last June was sentenced to 30 years in federal prison.

U.S. District Judge William A. McRae pronounced the maximum terms for John Wesley Elder, 29, on his guilty pleas to bank robbery and carrying a dangerous weapon.

Area Deaths

Harold Decker, 83, of 1340 Worthington Ave. Maitland, died Tuesday night at Lakewood Nursing Center.

Paper Bag Bandit Hits Sobiks Shop

A robber using a paper sack over his head for a mask last night took an undisclosed amount of cash from the operators of a Sobik's Sandwich Shop, French Avenue in Sanford.

Migrating Whales. Gray whales are 50,000, 50-foot-long mammals of the sea. They migrate 12,000 miles every year, from their feeding waters in the Arctic Ocean to their breeding grounds off Mexico's Baja California.



WINNER SID IGLETON. Memorial Award.

COLOR ME GREEN—United Fund of Seminole County is near halfway point in making goal it was revealed at report luncheon hosted Wednesday by Sanford Rotary Club.

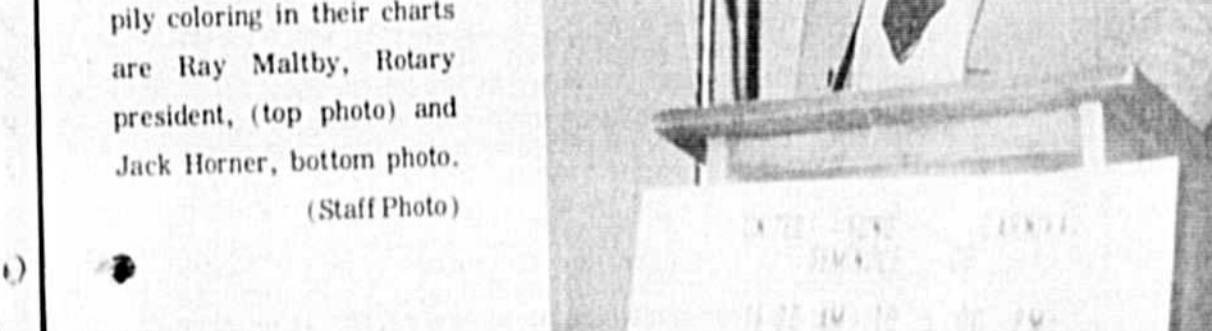

\$40,000 Collected UF Near Halfway

By BILL SCOTT

United Fund of Seminole County is near the halfway mark in its quest for an all-time goal of \$82,000.

Senate Control Up In Air

TALLAHASSEE, Fla. (AP)—Gov. Reubin Askew and a group of Republican senators are separately mapping their strategies for control of the Florida Senate.

"We are already working out quiet plans for the November election," Askew said Wednesday, with his aides evaluating each legislative candidate's race.

Fire Protection Study Is Ordered

By DONNA ESTES

LONGWOOD—Planner Harlan Hanson will be asked to place particular emphasis on fire protection in his studies for the CALNO Council of Local Governments, which are to begin any day.

Fire Protection Study Is Ordered

The studies costing \$25,000 are funded two-thirds by a state grant approved some six weeks ago.

Senate Control Up In Air

Major Kenneth Brown of Longwood said his city's fire department had been in a quandary about the proper action to take in the event of a fire.

Possession Of Marijuana Brings 5 Years Probation

By MARION BETHA

A defendant charged in a drug violation to whom Circuit Judge Richard Muldrew alluded as having "violated my trust" and "embarrassed the court" was placed on probation this morning by Judge Muldrew.

Charles Barrett Arnold was placed on five years probation by the court following probation for possession of marijuana.

Arnold was initially charged with possession and sale of a dangerous drug, and on July 13 pleaded guilty to possession of a dangerous drug. He was placed on probation for five years.

Fire Protection Study Is Ordered

By DONNA ESTES

LONGWOOD—Planner Harlan Hanson will be asked to place particular emphasis on fire protection in his studies for the CALNO Council of Local Governments, which are to begin any day.

Senate Control Up In Air

TALLAHASSEE, Fla. (AP)—Gov. Reubin Askew and a group of Republican senators are separately mapping their strategies for control of the Florida Senate.

"We are already working out quiet plans for the November election," Askew said Wednesday, with his aides evaluating each legislative candidate's race.

Fire Protection Study Is Ordered

The studies costing \$25,000 are funded two-thirds by a state grant approved some six weeks ago.

Senate Control Up In Air

Major Kenneth Brown of Longwood said his city's fire department had been in a quandary about the proper action to take in the event of a fire.



THOMAS WILSON III, of Rochester, N. Y., has been appointed as secretary-executive director of the Sanford Housing Authority to direct its 800 units of low rent housing.

RE-ELECT AL DAVIS

County Commissioner District 1, Dem., Al Davis, has been elected to a second term.

PRICED TO CLEAR! Ladies and Children's SHOES \$1.00 pair MANY TO CHOOSE FROM ARMY-NAVY SURPLUS



4 reasons (including price) to pick Ford's Courier over other imports

Advertisement for Ford Courier van, highlighting features like 1800cc overhead cam engine, 4-speed transmission, and 10 tie-downs. Includes contact information for Ford dealers.

Noon Stock Report

Table listing stock prices for various companies including Alcoa, Am Bldg, Am Bldg, Am Bldg, etc.

Photos

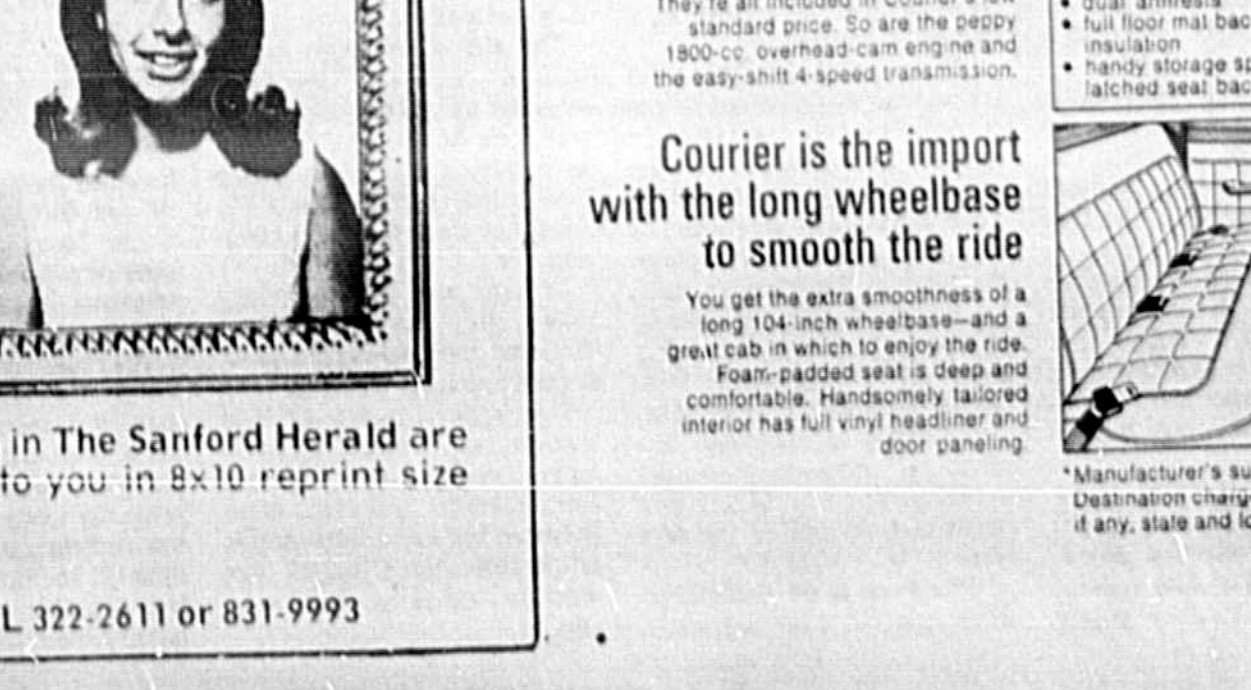

Photos. A photograph of a woman, likely related to the 'Paper Bag' article.

Editorial Comment Political Spotlight Now On Congress

As the primaries give way to the contests which nominated candidates — Democrat and Republican — are staging for the Nov. 7th general elections, there are two special aspects that deserve attention.

Thanks, Sir!

The word from Postmaster General Elmer T. Klassen is that the control program in the Postal Service has been so successful it is no longer necessary to seek an additional one cent an ounce in first-class mail rates next year.

Point of View ABC's Olympic Coverage Was Tops

HOLLYWOOD — The Once-Over: There's this radio fellow in Houston named Tom Tate, who has set a record for consecutive rides on a roller coaster. That completed no less than 500 rides, topping the previous record of 465 rides in 34 hours.

Capital Touch Politicians Do Need Health Tests?

By EDWARD NEILAN Copy News Service WASHINGTON — How healthy is your candidate? The political selection process is enhanced by use of objective data derived from modern instruments.

Offbeat Ruminations "Crocodile Tears" For Job Haters

By HAL BOYLE A vegetarian in a sausage-stuffed factory. Supply officer for Dracula. Valet at a hippie commune. Orthopedist for Joe Namath.

Political Notebook With Agnew, It's A Noncampaign

By BRUCE BLOSSAT Going around with Vice President Agnew is what you might call Phase 2 of his noncampaign of 1972. Sen. George McGovern has a lock on Phase 1.

For Contempt Of Court Glenn Turner Faces Jail

CLEARWATER, Fla. (AP) — Glenn W. Turner was jailed for five hours Wednesday after a demonstration by a group of women supporters outside a courtroom.

New Dade Mayor Has Ups, Downs

MIAMI (AP) — Next Monday, Jack Orr will be 53 years old. In that span of time he has been lawyer, banker, businessman, alcoholic, confirmed non-alcoholic, atheist, religious, legislator, winner in politics, loser in politics, rich, indebted, divorced four times, reformed and reformer.

Senate Slaps Nixon

By JOHN CHADWICK Associated Press Writer WASHINGTON (AP) — With quick and decisive votes, Congress has overridden President Nixon's veto and granted 900,000 retired railroad workers a temporary 20-per-cent increase in pension payments.

Senate Ready To Act On Welfare Measure

By JOE HALL Associated Press Writer WASHINGTON (AP) — After shepherding the key question of the AFDC rolls, the Senate jinked the welfare program which evolved from many months of work in the Senate Finance Committee.

One Man's Opinion President Can't Win for Losing

By DON OAKLEY According to Stephen Hess, one-time White House aide to President Nixon, his former employer reduces interest as an election issue, he will increase the possibility of his defeat in November.

Legal Notice

- IN THE CIRCUIT COURT FOR SEMINOLE COUNTY, FLORIDA. NOTICE OF FICTITIOUS NAME STATEMENT. NOTICE TO WHOM IT MAY CONCERN: This notice is hereby given that the undersigned, purchaser, is the purchaser of the following real estate...

HERALD EDITORIAL editor Stafford Derby, a veteran journalist with many years experience in observing the political scene, spoke to a group of 100 Trinity Preparatory School students and a question and answer session.

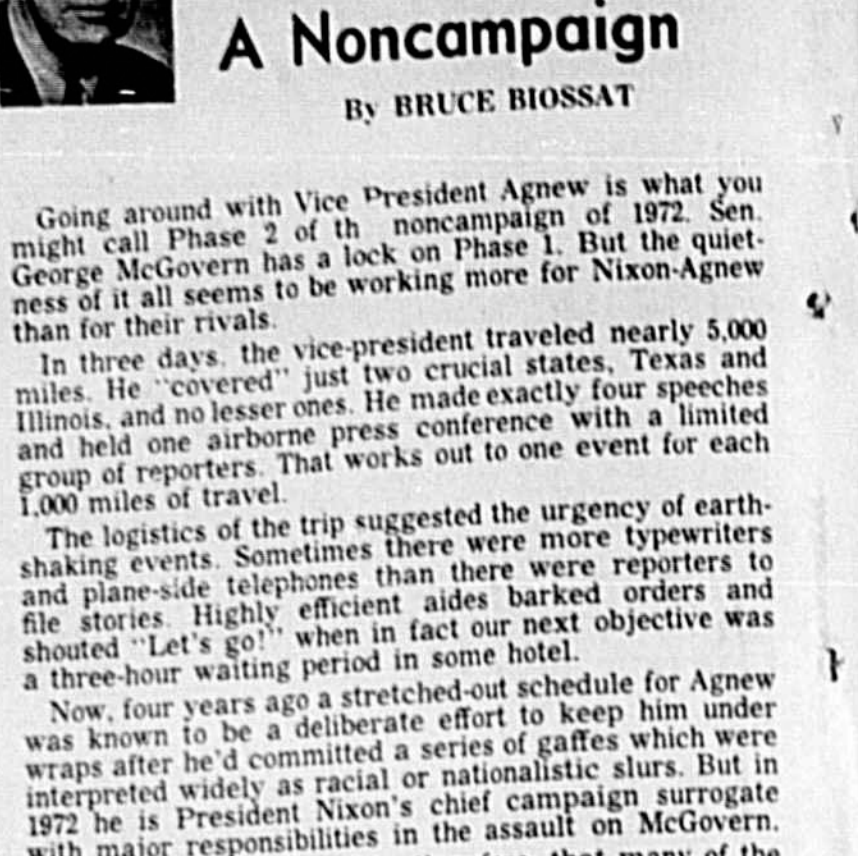

Overrides Pension Veto

Congress Slaps Nixon

Senate Ready To Act On Welfare Measure

One Man's Opinion President Can't Win for Losing

Legal Notice

Advertisement for 'BERRY'S WORLD' featuring a cartoon illustration of a man and a woman sitting at a table, with the text 'It all started, girls, when I realized that there is more to life than a career, and began groping for something meaningful to do with my time...'

Political Notebook

With Agnew, It's A Noncampaign By BRUCE BLOSSAT Going around with Vice President Agnew is what you might call Phase 2 of his noncampaign of 1972.

Thanks, Sir!

The word from Postmaster General Elmer T. Klassen is that the control program in the Postal Service has been so successful it is no longer necessary to seek an additional one cent an ounce in first-class mail rates next year.

Point of View ABC's Olympic Coverage Was Tops

HOLLYWOOD — The Once-Over: There's this radio fellow in Houston named Tom Tate, who has set a record for consecutive rides on a roller coaster.

Capital Touch Politicians Do Need Health Tests?

By EDWARD NEILAN Copy News Service WASHINGTON — How healthy is your candidate? The political selection process is enhanced by use of objective data.

Political Notebook

With Agnew, It's A Noncampaign By BRUCE BLOSSAT Going around with Vice President Agnew is what you might call Phase 2 of his noncampaign of 1972.

For Contempt Of Court Glenn Turner Faces Jail

CLEARWATER, Fla. (AP) — Glenn W. Turner was jailed for five hours Wednesday after a demonstration by a group of women supporters outside a courtroom.

New Dade Mayor Has Ups, Downs

MIAMI (AP) — Next Monday, Jack Orr will be 53 years old. In that span of time he has been lawyer, banker, businessman, alcoholic, confirmed non-alcoholic, atheist, religious, legislator, winner in politics, loser in politics, rich, indebted, divorced four times, reformed and reformer.

Senate Slaps Nixon

By JOHN CHADWICK Associated Press Writer WASHINGTON (AP) — With quick and decisive votes, Congress has overridden President Nixon's veto and granted 900,000 retired railroad workers a temporary 20-per-cent increase in pension payments.

Senate Ready To Act On Welfare Measure

By JOE HALL Associated Press Writer WASHINGTON (AP) — After shepherding the key question of the AFDC rolls, the Senate jinked the welfare program which evolved from many months of work in the Senate Finance Committee.

One Man's Opinion President Can't Win for Losing

By DON OAKLEY According to Stephen Hess, one-time White House aide to President Nixon, his former employer reduces interest as an election issue, he will increase the possibility of his defeat in November.

Legal Notice

Advertisement for 'The Official ASSOCIATED PRESS ALMANAC 1973' featuring a photograph of a man and a woman, with text 'The Almanac with the authority of the world's largest news organization...'

Advertisement for 'AL DAVIS' County Commissioner District 3, with a portrait of Al Davis and the text 'RE-ELECT AL DAVIS'.

Advertisement for 'SUMMER SIZZLER' featuring a photograph of a refrigerator-freezer and the text 'Giant freezer storage! Extra fast ice!'

Advertisement for 'Underwater Lab Tested' featuring a photograph of a diver and the text 'RIVIERA BEACH, Fla. (AP) — A new underwater laboratory, complete with separate living and work rooms and a garage for midge submarines, has been launched for test runs Wednesday before being taken to its operational base in Puerto Rico.'

Advertisement for 'Facts... AT YOUR FINGERTIPS!' featuring a photograph of a hand holding a pen and the text 'The Official ASSOCIATED PRESS ALMANAC 1973'.

Advertisement for 'The Associated Press Almanac is a handy research tool that belongs in every home, school, library and office. Tens of thousands of facts—elections, religion, sports, plus lots more—are available at your fingertips. Order your copy today by mailing the attached coupon.'

'Candid Chatter'

A Visit With Alice In Wonderland

By DORIS WILLIAMS
Society Editor

FANN-TASS-TICK!
GURRRR-ATE!
BETTER-YOUR-BEST!
GO-GO-GO!

Mmmmmmmmm (oney)! These are but just a few of the words and clichés clicking and chattering in a luxurious atmosphere at a party I attended Sunday afternoon.

After ascending the spiral staircase which was carpeted in rich crimson black pile.

SPECIAL PIANO
\$12 RENTALS \$12
MONTHLY
WITH PVT. LESSONS

CANNON MUSIC CO.
1601 S. Orlando Ave., Maitland, 444-7459
1244 E. Colonial Dr., Orlando 843-3706

Lost 80 lbs!

When I started on the X-11 Plan, I weighed 205#. Now I'm down to 125#. Some of my friends put me on a diet and called me back. They can't believe it's the same old Marge.

EAT WELL...WHILE YOU LOSE THAT UGLY FAT

So you want to lose 5, 10, 25 or more pounds of excessive weight? Now with the X-11 Reducing Plan, you can remove pounds and inches from thighs, neck, legs, waist... ALL OVER... while you eat well.

SATISFACTION GUARANTEED OR MONEY BACK

Get your X-11 Reducing Plan today. If it fails to do what you want, just return your empty flat package for an immediate refund. No questions asked.

ECKERD DRUGS

Trissi Tops from \$14

Large Assortment Trissi Tops from \$14

Bold, beautiful, decidedly Trissi. Made of washable Polyester, here's a long sleeved print pullover that's sure to be the delight of your new wardrobe. To exciting combinations. Polyester side pull-on pants that come in a wide choice of washable colors. Top in Sizes S-M-L. Pants in Sizes 7-19, 8-23

Pants From \$12

BANKAMERICARD MASTER CHARGE

trissi
... a happy fashion

226 E. First St. Dia 322-3524

there she stood... ALICE IN WONDERLAND. The beautiful, blonde stagsuque (and curvaceous) Alice is the wife of GLENN W. TURNER.

No, Alice was not wearing a sweet little Alice blue gown. She was attired in high-fashion modes... no doubt from the House of Alice or Alicia Fashions. Complementing her black faille flared was a turquoise ribbed knit over-bustle with double rows of self-ripples enhancing the V-neckline and bracelet-length sleeves. Her shoes were black suede trimmed in gold.

Whoa! Maybe I better start at the beginning. What was all thought was going to be a picnic for news media at the 1.6 million dollar castle of THE TURNERS emerged as a gala, glorified, GURRR-ATE cocktail party. After reaching the high fence surrounding TURNERDOME, under the scrutiny of a staff

of photographers and news photographers, I was royally greeted by TURNOTS. I refer to Glenn's followers in this manner since many of the companionshiped, compassed in Turner Enterprises, Inc., end in "-co-". Glenn admitted in a biography that he "borrowed" the word from Walt Disney World's EPCOT... community of tomorrow.

The living room is outta sight! Centering the room, which is also carpeted in crimson, is a large round stone fireplace constructed with a bench seating area. Hanging overhead, from the beamed, conical ceiling, is a hammered brass chandelier.

Surrounding the fire place are two semi-circles of elegant sectionals upholstered in gold and red striped velvet. Intimate groupings of solid red and gold velvet chairs and sofas with tables overlook panoramic Bear Gulley Lake through a wall of floor-to-ceiling windows draped with white embossed sheers.

The distinctive walls of the west "area" are of a gold and red striped paneling. They are strips of rough-sawn black walnut, laminated together.

Everybody, including about 150 TURNOTS and NEWSOTS, was as bubbly as the champagne which flowed freely from a large tiered fountain. A pedestal silver bowl was brimming with fruit punch for the "teetotalers", and by the by, Glenn does not imbibe nor puff!

A pot pourri of FANN-TASS-TICK finger fare, was served the guests... I'm sure the best that Meiner's Catering Service had to offer.

The happy host hospitably mingled with the guests natively attired in colorful, flamboyant threads... probably from the House of Glenn. He wore a crimson knit crew shirt, burgundy and magenta checked slacks with a jeweled flap pinned to the lapel of his white, belted double knit blazer and light leather flecked boots.

Am told the dapper tycoon had more than 40 pairs of boots in his wardrobe which could just stem from barefoot plowing days when once he saved a dollar, walked 15 miles to the nearest town to get shod to find that his lone buck would buy only a pair of sneakers.

Dare to be great anyone? Aw c'mon... everybody's great already... but according to GLENN THE GREAT... can be greater.

COMPLETE SELLOUT ALL CHILDREN SHOES
CANVAS - CASUAL - OXFORDS - LOAFERS - DRESS - BUCKLES

SIZES
B - C - D Widths
Children 8 1/2 to 12
Youth 12 1/2 to 3
Teens 3 1/2 to 7

508 Pr Girls All Now 288
274 Pr Boys Only

Drastic Reductions On All Men & Women Shoes

SALE STARTS FRIDAY, OCT. 6 9 A.M. WHILE THEY LAST

Hurry Hurry TO Cowans

214 E. First Downtown Sanford 322-4981



GLENN TURNER, center, pauses to chat with Mr. and Mrs. Walter A. Gielow at an appreciation party for news media at his Seminole County estate.

she was not allied with any local organizations. Most of her time is spent being a homemaker and entertaining TURNOTS and TURNERDOME. She briefed me on the women's fashions of the two companies and gals, they sound GURRRR-ATE!

I questioned Alice about servants and she responded that there would probably be one for each floor. Her proposed furnishings and fixtures... many imported... sound positively exquisite.

FANTASTIC! YLAND would not be complete without fairy-tale inhabitants... and would you believe, dwarfs? It is universally known that GLENN THE GREAT is partial to the handicapped who are among the vast throngs of TURNERDOME.

At the party I met a pair of twins... 33 inches tall... JOHN AND GREG RICE. Any of you who have the PLOMS (poor little old me sickness), should talk to these 20-year-old live wires.

I had a ball talking to them and upon departing the scene they were in a shiny '73 Cadillac... with the seat and controls elevated to fit their small frames.

They offered to take me for a ride in the caddy and also on a Lear jet... which Glenn also offered to all of us.

TURNOTS criss-cross the skies, in their Lear's and other aircraft... more than I sashay Lake Monroe and Sanford Plaza... and I sorta cover a little ground!

Well, dear hearts, I could write an unending novel about the delightful experiences of the afternoons... But don't take my word for it... just ask any of the ANGELS



FANN-TASS-TICK! This is just how Doris Williams, left, feels about Mrs. Glenn (Alice) Turner after an interview at the gala news media party Sunday.



IT'S JUST gotta be GURRRR-ATE—whatever it is Glenn Turner, left, and Mr. and Mrs. Frank Voltoline are discussing at the party at TurnerDome.

COMPLETE SELLOUT ALL CHILDREN SHOES
CANVAS - CASUAL - OXFORDS - LOAFERS - DRESS - BUCKLES

SIZES
B - C - D Widths
Children 8 1/2 to 12
Youth 12 1/2 to 3
Teens 3 1/2 to 7

508 Pr Girls All Now 288
274 Pr Boys Only

Drastic Reductions On All Men & Women Shoes

SALE STARTS FRIDAY, OCT. 6 9 A.M. WHILE THEY LAST

Hurry Hurry TO Cowans

214 E. First Downtown Sanford 322-4981

The Fall Ensemble



A variety of expressions on coat and dress ensembles is at maryl'esthers. Relaxed shapes in unexpected costumes to carry over into evening. Come See...

maryl'esthers
200 PARK AVE. N., SANFORD

Miss Linda Ann Seymour Engaged To Marry Steven Alan Ison

PLAYTEX
i can't believe it's a girdle
NEW HIGH WAIST GIRDLE

Yes, you can have a smoother midriff... comfortably... with the same unbelievable control and unbelievably lightweight fabric that made "I can't believe it's a girdle" the greatest girdle news of the year.

- exclusive self-adjusting waistband that resists roll and won't pinch...
- controls your waist without bones or stays
- unique design... easy to put on... without bulky zippers that pinch and snag
- made of a sensational fabric that gives you the control of paneled girdles weighing 50% more

Available in:
High Waist Girdle (M, L, XL, XXL) \$16.00
High Waist Panty (M, L, XL, XXL) \$18.00 (XXL, XXXL \$1.00 More)

Mr. and Mrs. Wilmer T. Stapleton, 203 Bradshaw Drive, Sanford, are announcing the engagement and approaching marriage of their daughter, Miss Linda Ann Seymour, to Steven Alan Ison, son of Mr. and Mrs. Truman Ison, 111 W. Woodland Drive also of this city.

The bride-elect, who is the daughter of the late Richard A. Seymour, is the granddaughter of Donald L. Cabels, Miami, and Mr. and Mrs. William E. Anderson, Daytona Beach. She is the niece of Mrs. William Kirk, Sanford.

Born in El Paso, Texas, Miss Seymour is a 1972 graduate of Seminole High School where she was a member of Future Homemakers of America and during her senior year was vice-president of Business Leaders of America. She is continuing her education at Seminole Junior College.

Her fiance who was born in Orlando is the grandson of Mrs. Mae E. Hulst, Orlando, and Mr. and Mrs. Derie Ison, Dayton, Ohio.

A 1971 graduate of Green High School, Enon, Ohio, Mr. Ison is employed at Art Grindle Dodge, Orlando.

The wedding will be an event of Nov. 25, at 8 p.m., at Pinecrest Baptist Church.

Manuel Jacobson
DEPARTMENT STORE
213 E. FIRST ST. PH. 322-4712

the costume makers
Hats are back and beautiful... Add gloves, and purse, to complete the perfect costume effect.

For your casual moods we suggest boots beneath the knee and short pant boot styles

priced from \$3.99

THE HUGGER
Open Fri. Evenings

Knights
208 E. FIRST ST. DIAL 322-0204

Miss Kay Louise Deppen, 90 Plumosa Dr., Casselberry, and Richard E. White, Orlando were united in Holy Matrimony, Sept. 6, 1972 at 7 p.m. in the United Methodist Church, Casselberry.

Officiating clergyman at the double ring ceremony was the Rev. William Pickett, Organist, Mrs. Charles Pierce, presented appropriate nuptial selections.

The bride is the daughter of Mrs. Robert Deppen, 90 Plumosa Drive, Casselberry, and the late Mr. Deppen. The groom is the son of Mr. and Mrs. Herbert White, Marshall, N.C.

Given in marriage by her brother, Thomas Deppen, Sanford, the bride wore a formal-length gown of white lace, over satin, princess styled with a scooped neckline outlined with three rows of seed pearls. The long lace bell-shaped sleeves ended in scallops over her wrists.

Her three-tiered elbow length veil of silk illusion was attached to a headpiece of three lace roses outlined with seed pearls and she carried a cascade bouquet of sweetheart rosebuds, carnations, baby's breath with ribbon streamers interspersed with greenery.

Miss Teresa Shearer, Casselberry, was maid of honor. She wore a formal-length gown of floral flocked polyester, empire styled with a scooped neckline and tiny white braid roses outlining the waist and neckline. Her headpiece was a yellow satin ribbon bow with streamers and she carried two long-stemmed yellow roses with matching ribbon streamers.

Bridesmaids were the Misses Lori and Donna Deppen, sisters of the bride. Their gowns were identical to the honor attendant's except in color. Lori wore mint green and Donna, pink. They carried two long-stemmed white roses, each tipped the color of their gowns. All of the gowns were made by the bride's mother.

Michael Beagler, Orlando, was best man.

The bride's mother wore a pale blue double knit dress with white accessories and a corsage of white carnations tipped in blue. The groom's parents were unable to attend.

Mrs. Florence Meyer, Sanford, maternal grandmother of the bride, wore a blue and beige double knit dress with beige accessories.

Following the ceremony, a reception was held at the home of the bride's parents in Casselberry. The bride's table, overlaid with a white linen cloth was adorned with the bride and her attendant's bouquets. The

Kay Louise Deppen, Richard E. White Exchange Vows In Double Ring Rites

Holy Cross Churchwomen Set Annual Fall Luncheon

The women of Holy Cross Episcopal Church will meet for their Fall Luncheon session, Monday, Oct. 9, at noon in the Parish Hall.

All women of the church are cordially invited and are asked to bring a salad or dessert.

A highly entertaining program, a Serio-Idiotic-Dramatic-Theosoc production entitled, "The Call of All," will be performed by Holy Cross Parish Players.

Bram Towers residents needing a ride are asked to call the church office, 322-4611, and transportation will be arranged.

ACT III
Classics for discriminating women.

Jacquarded fit-conscious blazer. Sleeveless ascot-neckline shell. Smoothly yoked pleat-filled skirt. Yoked to match or contrast also available.

LAYAWAY BankAmericard Master Charge

The Village Shop
Ph. 322-9180
2640 Hiawatha Sanford

B.E. Purcell Company
124 W. CHURCH ST. DOWNTOWN 201 E. 1st ST. OHLANDSO 422-3261 SANFORD 322-1494



MISS LINDA ANN SEYMOUR (Bob Orwig Photo)

it's a... sale!
Until Oct. 14...so make your selection early.

ALL FURNITURE IN STOCK 10 to 50% off

Meadowcroft, Molla, Tropitone, Woodard

There are SAVINGS here you will have to see to believe.

ALL ACCESSORIES
Brass, Leather and Wrought Iron
10 to 40% off

A FEW FIREPLACE ENSEMBLES 40% off

Orlando Forge, Inc.
Master Craftsmen and Designers
711 ORANGE AVENUE TELEPHONE 447-3524
WINTER PARK, FLORIDA 32789

GILBERG'S KNITS SALE

Entire Stock... 100% Polyester
60" DOUBLE KNITS
FANCIES & SOLIDS
MACHINE WASHABLE

Reg. 3" yd... \$1.66 yd.
Reg. 4" yd... \$2.66 yd.
Reg. 5" to 9" yd... \$2.00 off per yd.

100% Acrylic...
HAWAIIAN PRINTS
45" WIDE... MACHINE WASHABLE... BIG SELECTION...
Reg. 2" yd... \$1.99 yd.
SAVE... 99¢ yd.

Concord's... Perma-Prest
KETTLE CLOTH
Entire Stock Reduced
Prints 'n Solids
Polyester/Cotton Blend
Reg. 1" yd... 97¢ yd.

you can depend on gilbergs

GILBERG'S KNITS SALE

Entire Stock... 100% Polyester
60" DOUBLE KNITS
FANCIES & SOLIDS
MACHINE WASHABLE

Reg. 3" yd... \$1.66 yd.
Reg. 4" yd... \$2.66 yd.
Reg. 5" to 9" yd... \$2.00 off per yd.

100% Acrylic...
HAWAIIAN PRINTS
45" WIDE... MACHINE WASHABLE... BIG SELECTION...
Reg. 2" yd... \$1.99 yd.
SAVE... 99¢ yd.

Concord's... Perma-Prest
KETTLE CLOTH
Entire Stock Reduced
Prints 'n Solids
Polyester/Cotton Blend
Reg. 1" yd... 97¢ yd.

you can depend on gilbergs

SANFORD PLAZA PH. 322-4232
Open 10-4 Daily
Open 11-9 am, Mon. & Fri.
Closed Sunday

TRACK TALK

with George Crossley



National Speed

Fans going to Charlotte Motor Speedway for the National 500 race will find improvement, quality and plenty of racing excitement.

The excitement will come from the great entry field featuring the top names in American motorsports as the best of NASCAR and the United States Auto Club (USAC) are entered in the \$123,600 event on Oct. 8.

The improvement and quality will be found around the track and in the numerous concession stands. Over 750 gallons of paint have been applied to the grandstands. The buildings that the quality goes beyond that.

National Sports Concessions recently entered into an agreement with the mile and a half superspeedway to handle the food service starting with the 500-mile on Sunday, Oct. 8.

As part of the firm's program they replaced all of the equipment with the most modern and efficient food preparation devices, and steam-cleaned every concession stand that will accommodate the more than 80,000 race fans anticipated.

The second part of National Sports Concessions program was to purchase the top quality food and drinks and upgrade standards of race food, meals and snacks.

Richard Pett has Pete Hamilton for a teammate again for this event and as reported previously the Wood Brothers will have twin Mercurys with David Pearson and A. J. Foy behind the wheel. Bobby Isaac has a ride for this race also. He will be piloting a Banjo Mathews prepared Chevrolet.

As part of the firm's program they replaced all of the equipment with the most modern and efficient food preparation devices, and steam-cleaned every concession stand that will accommodate the more than 80,000 race fans anticipated.

Autocross Set

The Martin Sportcar Club will host an Autocross Sunday, Oct. 15 at the Martin Marietta Company parking lot Building 10 near Orlando. Registration will be from 8:15-11:15 a.m. with practice beginning at 9:30 and concluding at 11:45 a.m. Timed runs will begin at 11:15. Contract Jim Ruse or Glen Saville at 647-4369. Everybody, whether club member or not, is invited to attend.

Ban On Sportscars?

Car and Driver Magazine has called attention to a very interesting state law which just went into effect in New Jersey. The law says that if your car doesn't pass a new emission test which is run by the State that you are warned to take remedial action. As of July, 1972 if you do not pass the State emission requirements are given 14 days to get the ride of your car or face criminal action from the state. This law does not take into account what year your car may be driving. The law is aimed at seeing that all vehicles eventually meet the emission standards by 1975. A similar federal law may be placed before Congress this year or in 1973.

My complaint with the law is that it doesn't take into account that John Doe's 1969 Z-38 Camaro won't be able to pass an emission test because that year the car wasn't equipped with the necessary pollution devices. Furthermore it's not possible for the owner to get the devices placed on the engine and even if he did they wouldn't be that effective for a very important reason. The Camaro engine that year was a high compression engine.

I am in favor of controlling and stamping out pollution. I am not in favor of laws either State or Federal that would actually force a car owner to ride his car or face State or Federal Criminal charges. If it auto enthusiasts aren't vigilant concerning this type of legislation the Sportscar will be legislated right out of existence and on a national level high performance cars may turn out to be in VIOLATION OF THE LAW! Think about it. Auto sports as we know and understand it may cease to exist if we don't begin protecting our interests.

This weekend the annual running of the U.S. Grand Prix from Watkins Glen New York.

The Can-Am moves to Laguna Seca Raceway on Oct. 15 for another round in the Can-Am Series.

There is no doubt that Team McLaren will have to come up with a Turbo-Charged to be able to race with the Penske Prepared Porsche Team in 1973. Decision should be forthcoming shortly.

Drag Finals

Entry blanks for the National Hot Rod Association's 1972 Annual World Finals Finals Dragway Finals will be placed in the mail to eligible competitors this week in preparation for the Oct. 20-22 classic which will decide drag racing's 1972 World Championships.

The \$220,000 World Finals event is the climax of NHRA's 1972 World Championship Series of 35 regional races across the U. S. and Canada, where participants earned points qualifying them for entry at Amarillo. Only the top points winners are invited to participate in the rich classic.

The World Finals event is being held in Amarillo for the second year following a four-year run at Tulsa, Okla., and two years at Dallas, Tex.

With a record purse of more than \$220,000 posted for the richest seasons ever for the sport, the 35-race WCS, which began last April, carried a posted purse of more than \$800,000.

In addition to the huge payoff, World titles in seven categories will be at stake including Top Fuel, Funny Car and Pro Stock in the professional and Regional and Competition, Modified, Super Stock and Stock Eliminator in the sports racing categories.

More than 300 eligible candidates, boiled down from an overall list of some 10,000 that competed in this year's World Championship Series on a Conference and Regional basis will be receiving official entry forms from NHRA Headquarters here.

Cincinnati Ends With Win Gibson Beats NL East Champs, 4-3

BY TOM EMORY
Associated Press Sports Writer
"People don't relate to past performances," said Manager Bill Virdon of the Pittsburgh Pirates. "They relate to play-offs and whether you win or lose."

Boston Tops Detroit, 4-1 In Final Tilt

BY BEN RAPPAPORT
Associated Press Sports Writer
The Detroit Tigers have won the championship of the American League Eastern Division and now head west for a game of higher stakes.

Next stop: Oakland, for the American League playoffs. "They call us the over-the-hill gang and things like that because of all the veterans on our squad," says Tiger pitcher Mickey Lolich. "But I don't think we're that bad."

Apparently, some of the bookmakers in Las Vegas don't think that the Tigers are that bad, either. They're rated a toss-up to win the best-of-five-game series from the A's, winners in the Western Division.

The Tigers, who closed out the regular season Wednesday with a meaningless 4-1 loss to the second-place Boston Red Sox, will deal Lolich in the first playoff game Saturday at the Oakland Coliseum.

NL Playoff Game Left Out Sunday

NEW YORK (AP) — The National Broadcasting Company will televise virtually all of the American and National League baseball playoff games beginning Saturday.

An NBC spokesman said Wednesday night that the first NL playoff game, Cincinnati at Pittsburgh Saturday, would be nationally televised at 1 p.m. EDT, followed at 4 p.m. by the opening AL games between Oakland and Detroit at Oakland.

The game procedure will be followed Wednesday—if both series have not been decided, if a fifth AL game is needed, it will be televised at 1:30 p.m. Thursday in Detroit.

his own cause against Pittsburgh by driving in the Cards' first run with a fifth-inning single. He also snapped his record of more than 200-strikeout seasons by fanning 11 Pirates and running his total to 208. It is the ninth season of 200 or more strikeouts for him.

Johnny Bench hit a fifth-inning sacrifice fly to provide the Reds' winning run. Earlier, Dave Concepcion had hit his second homer of the year for Cincinnati.



BREAKAWAY run by Page Airways Jeff Jones resulted in a touchdown for the Page Packers in their game with Jack Prosser Ford of Lake Mary in the YMCA Pop Warner league last Saturday at Sanford Stadium.

By One Point Gators Picked Over Seminoles Around The SEC

Another week-end of SEC football is over, and as always there were some surprises. Some were by the winners and other surprises by the slim margin of victory. This is SEC football. Practically every year any team is capable of winning.

Florida 28 - Miss State 13
Florida finally developed their running game. Gained 212 yards on 43 tries. Think the presence of Bowden helped keep State defense loose. State looked good at times, especially their opening touchdown drive.

Georgia 28 - NC State 22
Georgia got off light here. Recovering two fumbles and making three interceptions saved the Bulldogs. With score 14-14 at half, Georgia had to play for their life in second half.

LSU 27 - Wisconsin 7
Score could have been 47-7 for Wisconsin. The Northern team was held to 3-13 in passing. Got to speak highly of LSU secondary. Tigers offense did not fumble once or have an interception. Earned game for Tigers. Exceeded their national ranking in this one.

Alabama 48 - Vanderbilt 21
Tide trailed for first time this year 7-6 in first quarter. But rolling up 350 yards in 80 tries on ground and throwing for 5-9 for 80 yards was too much for Andy. Red Elephants front four can play hard for 60 minutes.

Mississippi 33 - Mississippi Southern 9
Rebels knew it. Southern always plays their best. But it was about caught asleep at the switch anyway. With Ole Miss quarterback getting three passes picked off and

Major League Standings

Final Standings National League				American League			
East	W.	L.	Pct.	East	W.	L.	Pct.
Pittsburgh	95	59	.619	Boston	87	70	.558
Chicago	85	70	.548	Baltimore	80	74	.519
New York	83	72	.534	New York	79	75	.514
St. Louis	75	81	.481	Cleveland	72	84	.462
Montreal	70	86	.449	Milwaukee	65	91	.417
Philadelphia	59	97	.378				
West	National League			American League			
Cincinnati	65	59	.520	Oakland	83	62	.571
Houston	84	69	.549	Chicago	87	67	.565
Los Angeles	85	70	.548	Minnesota	77	77	.500
Atlanta	79	84	.452	Kansas City	78	74	.514
San Francisco	69	86	.445	California	75	80	.484
San Diego	58	95	.379	Texas	54	100	.351
Wednesday's Results				Wednesday's Results			
Regular Season Ends				Regular Season Ends			
Philadelphia 2, Chicago 1	San Francisco 4, San Diego 4	St. Louis 4, Pittsburgh 3	Los Angeles 4, Atlanta 1	Cincinnati 4, Montreal 2	Philadelphia 4, Chicago 2	Boston 4, Detroit 1	Milwaukee 1, New York 0
Kansas City 4, Texas 0	Oakland 2, California 1	Only games scheduled					

SPEAKING OF TIRING PRACTICE. Some training aids originally designed for racing cars are being used by the Akron, Ohio, can handle.



JOCKEYING FOR POSITION—Lightning (8901), Samarkand (8950), Dorothy O (7477), and Tribute (right) maneuver in race off San Francisco, Calif. But none of these sloops won. The victor in City of San Francisco Perpetual Series was Dave Allen's Improbable.

George Blanda: The Contented Old Age of a Pro Football Phenomenon

BY MURRAY OLDERMAN
OAKLAND, Calif.—(NEA)—On the day the 1972 National Football League season officially began, George Blanda turned 43 years of age. For exactly half his lifetime, he has been actively involved in professional football as a player.

He is the oldest of the old in a precarious game where cruel physical risks and large pay-offs are a daily part of the life of the player. George Blanda, who has played for money before there was an NFL, might have been older for the scrimmage action.

Sanford Ladies Lose 1st Football Forecast

BY MAJOR AMOS B. HOOPLE
Wizard of Odds
Egad, friends, you are going to enjoy the pigskin scheduled for this week.

The Old Boy Himself
Southern California lads take on the Stanford Indians, a free-wheeling affair we look for the Trojans to romp home on the long end of a 36-28 score!

Predictions are for games of Oct. 7:
Southern Cal. 26, Stanford 28
Indiana 21, Syracuse 12
Louisville 26, Tampa 21
Arkansas 41, TCU 28
Texas Tech 54, Tulsa 24
Texas 30, Utah State 14
Bowling Green 18, Toledo 14
Tulane 27, Pittsburgh 11
UCLA 42, Arizona 14
UTEX, El Paso 12, Utah 7
Vanderbilt 21, Vanderbilt 14

Right Wrong Ties Pct.
To Date: 37 15 4 713
Last Week: 18 18 4 743

Bowling Standings

DAV BANTAMS			
Standings	W	L	
Two Plus One	9	3	
Ten Pins	9	3	
Transmission	9	3	
Twelve's	7	5	
Lucky Bowlers	7	5	
Groovy Groovies	6	6	
Eleven's	5	7	
Gutter Girls	5	7	
Hang Ups	4	8	
Lane Runners	4	8	
What???	4	8	
No Names	4	8	

Sanford Ladies Lose 1st

The Sanford Ladies Tennis team from Greenwood bent their initial net tournament of the season, losing 4-3 to the Orlando Ladies at Emma Spencer's courts.

Perhaps the most exciting match of the afternoon was the meeting which faced Erna Dangleman and Betty Reagan defeating the duo of Margaret Ledeburg and Dorothy Hied-brink. The first match went to the winners by a narrow 8-6 count. The losers came back to win the second set by 7-5 only to lose the third set by another 8-6 score.

Other results were:
Darlene Bastille and Mary Stenfabenning defeated Jeanette Alexander in straight sets, 6-3 and 6-4. The third meeting of the day saw Jane Lingle and Betty Harley defeat Brenda Levesque and Jay Pauphit, 6-4, 6-4.

Sports Briefs

Ted Williams, manager of the Texas Rangers, played in only one World Series. That was in 1946 when he hit 200 on 100 singles in 25 trips to the plate.

FALL FASHION FIRSTS!

"COORDINATES"

THE happening thing in men's fashion... a completely co-ordinated wardrobe... sportcoats, pants, shirts, and ties... all in 100 per cent polyester double knit!

Come see this "HIS OF FLORIDA" collection... at all 5 HIS STORES FOR MEN.

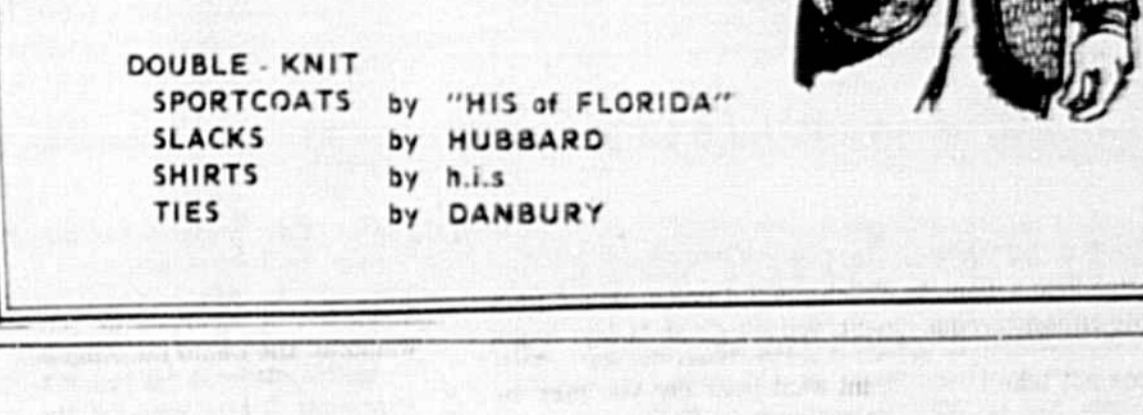

Learn to be something you're not.

Start a new career. Your local Army Reserve Command offers you 300 choices—from electronics and communications to auto mechanics and finance, depending upon the specific skill requirements of the local unit.

You're paid while you learn. And you're paid while you serve for four 4-hour sessions a month with us and two weeks each year. Call toll free, 9 AM to 8 PM. Dial 800-432-7290. Or mail this coupon.

Army Reserve Opportunities
P.O. Box 20004
Orlando, Florida 32814

Tell me all the reasons why it pays to go to meetings and give me more information about the Reserve unit near my community. I understand. I'm under no obligation.

Name: Mr./Mrs./Ms.
Address: _____
City: _____
State: _____ Zip: _____
Current Employment: _____
Phone: _____
Age: _____

Military Background (list units): _____
Branch: PANTS SMOOS Date of Separation: _____ 2-05

The Army Reserve. It pays to go to meetings.

Buying Refrigerator? Choose Carefully



By RICH SEELYE
Copy News Service

If you are thinking of buying a refrigerator you had better choose carefully because it will be a choice you'll have to live with for a long time.

Ex-Solon To Speak To GOP

ERNEST D. Baint, senior vice president-marketing for the Deltona Corporation, has been appointed to the board of directors for the First Bank of Deltona. The Miami-based executive joined Deltona in 1962 as assistant general sales manager.

Last year my wife and I made the mistake of buying a refrigerator that was too small. We thought it was a good buy because it didn't cost very much. We since have found out that there is more to getting a bargain than buying the cheapest thing you can find.



RICK SPRINGFIELD
Day parade, wearing a wine-colored "rock star" shirt. He said the company would put some advertising money behind Springfield.

JOSEPH C. Caldwell, of 100 McKay Boulevard, has been promoted to staff manager of Gulf Life Insurance Company. A native of Sanford, he is a graduate of Crows High School and NHL, Washington, D.C. He started with Gulf Life in 1969 and won the "Fabulous Freshman" award in 1970 and has made "Top Club" each year. He served as secretary-treasurer of the Seminole County Life Underwriters Association, is a past president of Hopper PTO and is a deacon, Sunday school superintendent and choir president of Zion Hope Baptist Church.

SCOTT'S

home builders supply

700 French Ave. Sanford, Ph. 323-4700

Scotty's Brand GARDEN TOOLS

YL220 Leaf Rake	96
YGB1 Garden Hoe	2.25
A2248F Open Back Shovel	2.48
AR248F Open Back Round Shovel	2.55
RHTE Turf Edger	3.39

My wife, Peggy wanted to check out the General Electric model with the ice maker in the door to dispense ice water, crushed ice and ice cubes. When we looked at one in the store we walked into, I carefully noted that it is 23.6 cubic feet, which is very large for a refrigerator. The refrigerator portion is 13 cubic feet and the freezer is 8.6 cubic feet.

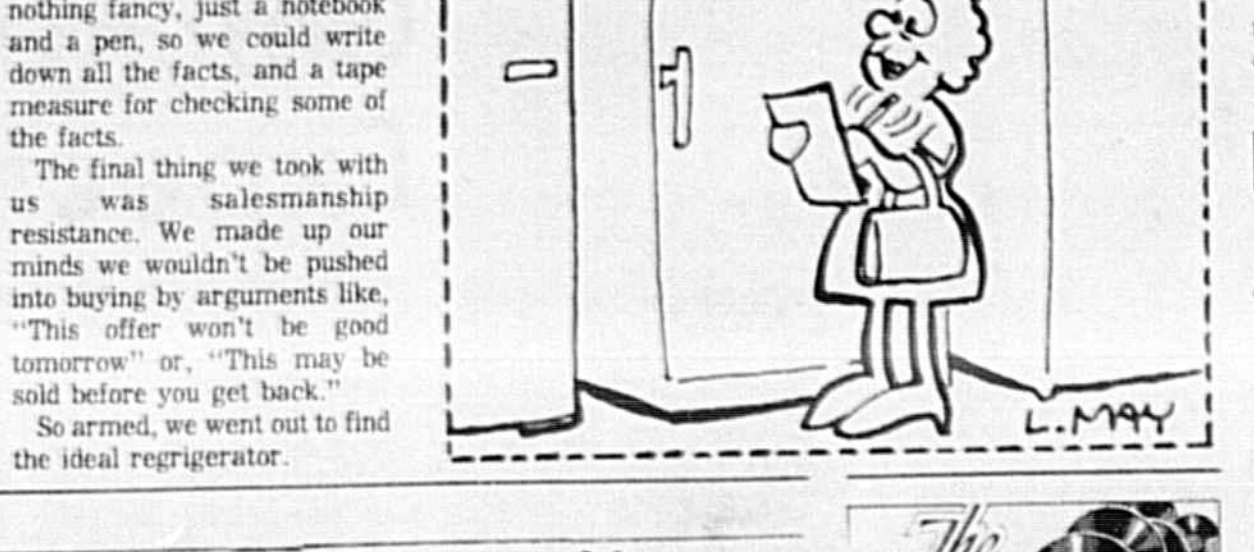

After making all the measurements to find out if the refrigerator would fit into our kitchen, I then began to figure if it would fit into our budget. The price of the giant General Electric model with the ice maker is \$790 plus \$10 for a "decorative cooler" plus \$20 to hook up the ice maker. That made the price for a colored one come to \$820.

My wife, Peggy wanted to check out the General Electric model with the ice maker in the door to dispense ice water, crushed ice and ice cubes. When we looked at one in the store we walked into, I carefully noted that it is 23.6 cubic feet, which is very large for a refrigerator. The refrigerator portion is 13 cubic feet and the freezer is 8.6 cubic feet.

Records Newcomer Works at Getting Known

By MARY CAMPBELL
AP-Newsletters Writer

Rick Springfield has come from Australia to the United States, without stopping in England to get well-known there, and he's getting well-known here.

My wife, Peggy wanted to check out the General Electric model with the ice maker in the door to dispense ice water, crushed ice and ice cubes. When we looked at one in the store we walked into, I carefully noted that it is 23.6 cubic feet, which is very large for a refrigerator. The refrigerator portion is 13 cubic feet and the freezer is 8.6 cubic feet.

New Officers Named At Maitland Bank

Donald C. Rogers, president of the First National Bank of Maitland, has announced the election of Max J. Esber, Jr. as vice president; Joseph J. Gucciardo as assistant vice president, and the promotion of Mrs. Mary P. Dawson to assistant vice president.



The above handmade clock will be shipped direct from West Germany factory within 14 days on receipt of order. Owl has moving eyes, gaily painted, 8" tall. Price for one clock \$14.25, two clocks \$25.00. Ppd. Satisfaction gtd.

The 5 foot Gestetner printing plant.

It takes only 50 in. of wall space and saves you \$5 on printing bills. You can lease the entire 5-piece unit - Gestetner, Gesteflex, Add-a-Deck, Cabinet and Gestite for as low as \$87 a month.



FOREST CITY Sertoma Club held installation of officers and charter night. Seated left to right, Kenneth Spandau, president; Dr. Lawrence Blum, vice president; standing, Lowell Stahl and Glen Doolittle, vice presidents.



COUNTY Commissioner Al Davis, guest speaker at Forest City Sertoma Charter Night chats with Mrs. Kenneth Spandau, wife of Sertoma president, and Mrs. Roy Weinberg.

Sertoma Club Founded

By ANN RILEY

FOREST CITY—Welcome to the City of Altamonte Springs! "Spring" was the greeting given by County Commissioner Alfred Davis, guest speaker, to members and guests of Forest City's new Sertoma Club. He was referring facetiously to reaction by Forest City residents to Altamonte Springs' recent move to annex another 400 acres of this unincorporated area.

FABRIC SALE

FASHION FABRICS DIRECT FROM AMERICAS FINEST MILLS

100% DOUBLE KNITS	FLANNELS
A beautiful selection of solid full colors. Darks, light & bold color shades. Permanent, machine wash and dry, 60" wide & on bolts.	Solid and printed flannel—great for warm winter sleepwear. 100% cotton machine wash and dry, 45" wide, designer lengths.
\$1.99 YD.	49¢ YD.

BETTER QUALITY FANCY DOUBLE KNIT

Finest quality! Fancy, yarn dyed 100% polyester double knits. Full bolts! 60" wide, easy care, machine wash and dry. Heavy-weight! Tone on tones & member patterns! Come save now! Values to \$4.99 YD.

\$2.99 YD.

ZIPPER PULLS	WIDE WALE CORDUROY
The newest fashion craze...our choice of versatile animal kingdom antique gold plated, or jeweled trim. The finishing touch.	Popular fall 100% cotton corduroy. Wide wide wale! 42" wide machine wash and dry. Finest quality. A sportswear favorite.
\$1 EA.	99¢ YD.

fabric FABRIC CENTERS

Sanford—Pinecrest Center
Next to Sears
Maitland—North Underpass
1601 S. Orlando Ave.

J. M. Smedley Enterprises

133 North Kentucky Avenue
Del Norte, Florida 32720

Sheer FABRIC Witchery

SHUP T.G.B.Y. FOR ALL YOUR SEWING NEEDS

FAST GROWING - FLOWERING

GOLDEN RAIN TREES

WHITE, PURPLE LAVENDER, PINK AZALEAS 1.98 4 OR MORE 1.75 EA. MORE 1.75

A-R-T-I-F-I-C-I-A-L PLANT SALE

4 1/2 FT. 6" BAMBOO	5 FT. 7 TRUNK 16" RAIN TREE 9 99
5 FT. 5 TRUNK 21" PHILO	16" 5 FT. 18" HI-COLOR CROTON 9 99
4 FT. 14" 6 TRUNK CROTON	6" 4 FT. 12" ENGLISH IVY 9 99
6 FT. 24" CAMELLIAS	16" 5 FT. 21" PHILODENDRON 16 99
6 FT. 22" BLOOMING YUCCA	12" 5 FT. 22" BAMBOO TREE 15 99
4 FT. DRACEANA MULTI	9" TO 12" 6 1/2 FT. 35" WISTERIA TREE 22 99
6 FT. 24" GARDENIA	16" 4 1/2 FT. 14" ORANGE TREE 6 99
6 FT. 37" MAGNOLIA TREE	29" 6 FT. 24" YEL. FORSYTHIA 18 99
6 FT. 24" HIBISCUS TREE	16" 6 1/2 FT. 32" MAPLE TREE 24 99

HYACINTH BULBS 3 FOR 1.00	ONION SETS
FOR WATER CULTURE	"PLANT 'EM NOW"
EVERGREEN CAMPHOR TREES 1.39	LIQUID FERTILIZER
	4.98 GAL. 2nd GAL. 1.00

GREENWAY ★ 50 lb Bags ★ FERTILIZERS

6-6-6-50% ORGANIC 2"	6-4-6-4 CITRUS 40% 2"
6-6-6-100% ORGANIC 3"	8-4-4 GREEN-ORGANITE 2"

GREENWAY NURSERY

OVER 28 YEARS ON WYMORE ROAD, BETWEEN FAIRBANKS & LEE ROAD, WINTER PARK
OPEN 7 DAYS A WEEK 9:00 to 5:30. NO. MAIL ORDERS

Start Early, Avoid Pitfalls To Retire

By BETH MOHR
Copy News Service

One of life's important milestones is the one you pass when school ends and career begins.

That's when 35 to 40 work years stretch ahead like a lifetime and thoughts and energies are centered upon job success.

That's also when plans for retirement should begin, no matter how difficult it is to believe that a career doesn't fill an average lifetime and that successful retirement needs long-range planning.

EATON'S AT-A-GLANCE 1972-1973 RECORD BOOKS

Week At-A-Glance of appointments on each double page spread. Fifteen minute intervals. Wire binding covers full writing surface.

#956 Cordova grain simulated leather cover. Dated. Colors black, blue, red, saddle with contrasting title panel. \$3.75 each

#955 Deluxe cream kid finish simulated leather portfolio. Separate tabbed address section with space for 2000 letters. Dated. \$7.50 each

PROFESSIONAL APPOINTMENTS

FREIGHT DAMAGED FURNITURE AT 1/2 OFF OR MORE

NOLL'S FURNITURE SALES

HWY. 17-92 CASSELBERRY

To Assure Yourself The Best News Coverage Of Seminole County - Be A Regular Subscriber To The Sanford Herald.

Just \$1.50 A Month. Try It... You'll Like It!

DELIVERED MONDAY THRU FRIDAY

Just Give Us A Call 322-2611—831-9993 or Just Drop Us A Note.

FAST GROWING - FLOWERING

GOLDEN RAIN TREES

WHITE, PURPLE LAVENDER, PINK AZALEAS 1.98 4 OR MORE 1.75 EA. MORE 1.75

A-R-T-I-F-I-C-I-A-L PLANT SALE

4 1/2 FT. 6" BAMBOO	5 FT. 7 TRUNK 16" RAIN TREE 9 99
5 FT. 5 TRUNK 21" PHILO	16" 5 FT. 18" HI-COLOR CROTON 9 99
4 FT. 14" 6 TRUNK CROTON	6" 4 FT. 12" ENGLISH IVY 9 99
6 FT. 24" CAMELLIAS	16" 5 FT. 21" PHILODENDRON 16 99
6 FT. 22" BLOOMING YUCCA	12" 5 FT. 22" BAMBOO TREE 15 99
4 FT. DRACEANA MULTI	9" TO 12" 6 1/2 FT. 35" WISTERIA TREE 22 99
6 FT. 24" GARDENIA	16" 4 1/2 FT. 14" ORANGE TREE 6 99
6 FT. 37" MAGNOLIA TREE	29" 6 FT. 24" YEL. FORSYTHIA 18 99
6 FT. 24" HIBISCUS TREE	16" 6 1/2 FT. 32" MAPLE TREE 24 99

HYACINTH BULBS 3 FOR 1.00	ONION SETS
FOR WATER CULTURE	"PLANT 'EM NOW"
EVERGREEN CAMPHOR TREES 1.39	LIQUID FERTILIZER
	4.98 GAL. 2nd GAL. 1.00

GREENWAY ★ 50 lb Bags ★ FERTILIZERS

6-6-6-50% ORGANIC 2"	6-4-6-4 CITRUS 40% 2"
6-6-6-100% ORGANIC 3"	8-4-4 GREEN-ORGANITE 2"

GREENWAY NURSERY

OVER 28 YEARS ON WYMORE ROAD, BETWEEN FAIRBANKS & LEE ROAD, WINTER PARK
OPEN 7 DAYS A WEEK 9:00 to 5:30. NO. MAIL ORDERS

WEEK-AT-A-GLANCE DESK EDITIONS

For general appointment records these books offer privacy and permanency not available with usual desk-calendar pads. Full week on double-page spread for organizing work and scheduling business or social appointments. Wire binding.

#120 Gold-tooled, kid finish simulated leather covers. Address section. 8 1/4"x6 1/4". \$3.75 each

MONTH-AT-A-GLANCE PLANNING BOOKS

Designed for those who must plan ahead these books are helpful in scheduling business and social events. Ample writing space is accorded each day. Past, current and four future months are always in view. Generous perforated memo sheets supplement the appointment section.

MONTH-AT-A-GLANCE ADMINISTRATOR

Practical engagement books for desk use in home or office. Featuring popular format. Daily blocks measure more than 2" square. Past, current, and four future months always in view. Carry-over dates, a three-year calendar, coast-to-coast area code map and hi-address pages included.

#1200 smooth, fine simulated leather cover (dated). 8 1/4"x6 1/4". \$2.00 each

WEEK-AT-A-GLANCE "JR." EDITIONS

People frequently use the 30 have found these Jr. books indispensable aids in organizing and planning their activities. Compact in size, they may be readily carried in pocket, purse, briefcase.

#1000 (dated or undated). Cordova grain simulated leather cover. Tabbed index address section. Size 6 1/4"x3 1/4". \$1.75 each

MONTH-AT-A-GLANCE RECORD BOOKS

A popular priced addition for those who must plan a month ahead to schedule business and social events. Ample writing space is provided for each day. Past, current and four future months are always in view. Perforated memo sheets supplement the appointment section.

#1200 (dated) Cordova grain simulated leather cover, size 8 1/4"x6 1/4". \$2.00 each

These are only a few of the famous Eaton AT-A-GLANCE record books. Now is the time to stock up for 1973.

George Stuart

FLORIDA'S LARGEST

Business Reply Envelope
FIRST CLASS PERMIT NO. 40, SEC. 343 FLOR. SANFORD, FLA.

CIRCULATION DEPT.

The Sanford Herald

P.O. BOX 1657
SANFORD, FLORIDA 32771

Phone: Orlando Area 241-3411. Cocoa 430-1242. Deltona Area 355-5202. Deltona South 481-3300. South Beach 232-6250. Titusville 346-2450.

The Weeder's Guide

By EARL ARONSON
AP Newsfeatures

Just as the artist uses pigments to paint beautiful pictures, so does nature use them to color your autumn. Of course weather and the breakdown in chlorophyll play their parts. This is how the autumn drama unfolds:

Many pigments that contribute to fall color are in the leaves from earliest spring but as spring progresses into summer the green pigment (or chlorophyll) dominates. As the chlorophyll breaks down in summer it is replaced steadily and the leaves remain green. But as the days shorten in September, production of new green slows and all the chlorophyll dissipates. Then other pigments take over, bringing a bright autumn color scheme.

Cool nights and warm days enhance carotenes, flavonoids and purples. Cold, below-freezing temperatures kill the leaf cells and eliminate new color formation. Genetic makeup and the amount of moisture in the soil are other color factors. The reason no two falls are exactly alike is that each tree has its characteristic colors and conditions vary annually.

Your Old Pointsettia
Did you save last year's pointsettia? September is the time to begin trying to make it bloom again.

If the plant was outdoors for the summer bring it in before the first frost and place it in a sunny window. Then put it in complete darkness from Sept.

BOOK REVIEWS

Barth's Legends Fall Flat

CHIMERA By John Barth
Random House, 308 Pages \$6.95

Near the end of "Chimera," Barth's latest work of fiction, one of the characters remarks, "It's a beastly figure, ill-proportioned, full of longeurs, lumps, lacunae, a kind of monstrous mixed metaphor..."

The remark isn't directed at the book, of course, but it could be used to describe large portions of the text — although, in fairness, there are scattered sections which are witty, well-written, thought-provoking.

Over-all, however, Barth's efforts at retelling three legends — often in contemporary idiom — fall flat, especially when that which is meant to amuse fails to do so.

The myths involved are those of Scheherazade, the comely lass with a flair for story-telling; Perseus, slayer of the turkey-to-stone-with-a-look-Medusa, and Bellerophon, rider of the winged-horse Pegasus and slayer of the fire-breathing Chimera.

The Scheherazade episode, narrated largely by the tale spinner's kid sister Danyazade, is the least interesting of the three segments, taking some 50 pages of convoluted prose to argue — fall flat, especially when that which is meant to amuse fails to do so.

The myths involved are those of Scheherazade, the comely lass with a flair for story-telling; Perseus, slayer of the turkey-to-stone-with-a-look-Medusa, and Bellerophon, rider of the winged-horse Pegasus and slayer of the fire-breathing Chimera.

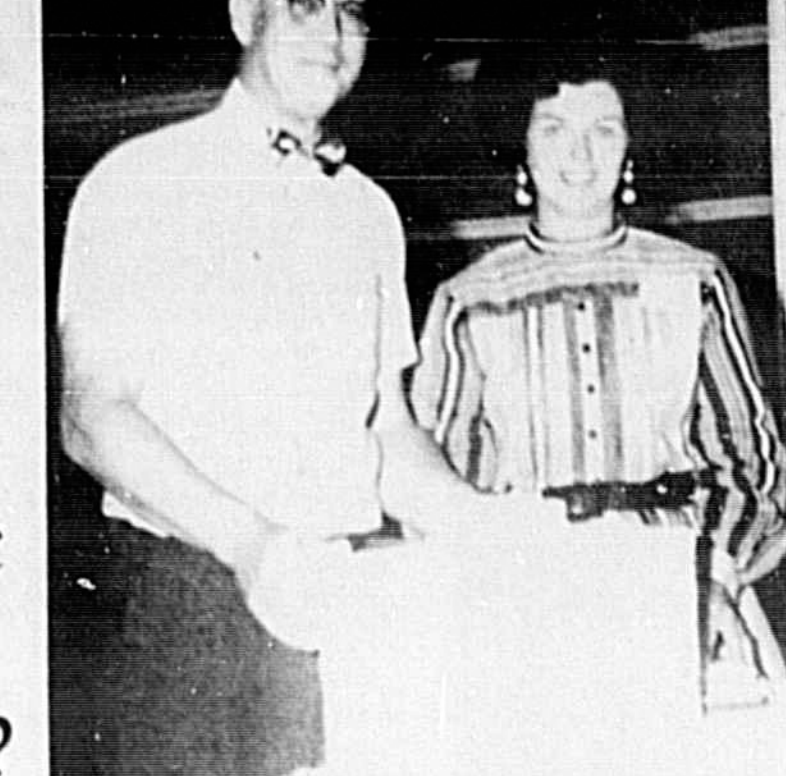

ELMER BELLHORN, the principal of St. Luke's Christian Day School in Slavia, is pictured with Mrs. Walter Judy (Duda), Parent-Teacher League president, as Mr. Bellhorn prepares to open a gift presented to him in observance of his 20th year in this capacity. (Liz Mathieux Photo)

St. Luke's School Is 25 Years Old

By LIZ MATHIEUX

SLAVIA — Observance of the school's 25th anniversary highlighted St. Luke's Christian Day School Parent-Teacher League's first meeting of the year.

At the meeting, Pastor John J. Kucharik was asked to give a brief synopsis of the 25 years of operating of the school and the church. It was brought about that the Parent-Teacher League had been in existence for 22 years. It was stated that St. Luke's School had grown from a class of 12 students to an enrollment of more than 300 children. There are 12 teachers on the staff. St. Luke's operates three buses daily for the convenience of the students.

Ferdinand Duda, president of the congregation of St. Luke's Church, was asked to introduce Principal Elmer Bellhorn and he referred to the fact that Bellhorn was the first male teacher to be hired at the school. He came as a principal teacher and has remained in this position for the past 20 years.

Mrs. Emmaline Best was one of the first women hired and she is also still with the school, teaching first grade.

A gift of a pen and pencil desk set with a small golden cross affixed was presented to Bellhorn as a token of remembrance.

A business meeting conducted by PTL President Judy Duda was short. The "hot luncheon program" was voted to continue for another year.

The school will conduct the annual book sale during the week of Oct. 16 at which time books purchased may be taken home. Hereafter, books were ordered and then made available. Hours for the book sale will be as follows: Monday, 6:30 to 7:30 p.m.; Tuesday, 7 to 9 p.m. Books also will be available during school hours.

Modern Tarzan Going To School

CHAPEL HILL, N.C. (AP) — The housing shortage at the University of North Carolina has driven many students "up the wall." It's driven Chip Hope up a tree.

Hope, 21, arrived at school this term for his junior year and decided that doubling up in a single room wasn't for him. He found a place to lay his head midway up a 40-foot pecan tree in a grove about five minutes from the campus.

Chip's \$20 home is a six-foot square wooden platform. It has a green tarp that keeps out some of the rain and a rope ladder, but no walls or electricity. "This isn't the place for someone who tosses and turns in his sleep," he says.

He calls his abode "Antler Lodge," after a society he belonged to while in high school. He reports having lived in it for two years, a dormitory, a house, a fraternity room, and a fraternity closet.

Entertaining is a bit more difficult.

"I had seven people up here for a party," he said. "And some were kind of hanging on the edges, and some were worried about whether the platform would hold together."

When the weather turns cooler, Hope says, he will move to more conventional quarters — a dormitory, a house, a fraternity room, and a fraternity closet.

His father, he says, has some advantages. It's cool on hot, humid days, and it's a good place to study.

Entertaining is a bit more difficult.

"I had seven people up here for a party," he said. "And some were kind of hanging on the edges, and some were worried about whether the platform would hold together."

STUTZ ALL-ALUMINUM PICK-UP TOPPERS & UTILITY BUILDINGS

FREE ESTIMATES • FINANCING AVAILABLE

LARGE SELECTION ON DISPLAY NOW!

BAKED ON ENAMEL FINISH — WON'T RUST 2" X 3" THERMITE TREATED CEDAR COVERED BY 1/2" PARTICLE WOOD FLOOR PATIO ROOFS, AWWING-SCREEN ROOMS ALUMINUM SIDING AND SOFFIT SYSTEMS

STUTZ ALL ALUMINUM TOPPERS, FITS LONG AND SHORT WOOD BASE & EL CAMINOS AND RANCHERS.

DELIVERED AND INSTALLED

15 ORANGE BLOSSOM CT. ORLANDO OPEN SAT. 422-7194
1445 N. ORLANDO AVE. MAITLAND, FL. 327-4898

HOMES FOR AMERICANS

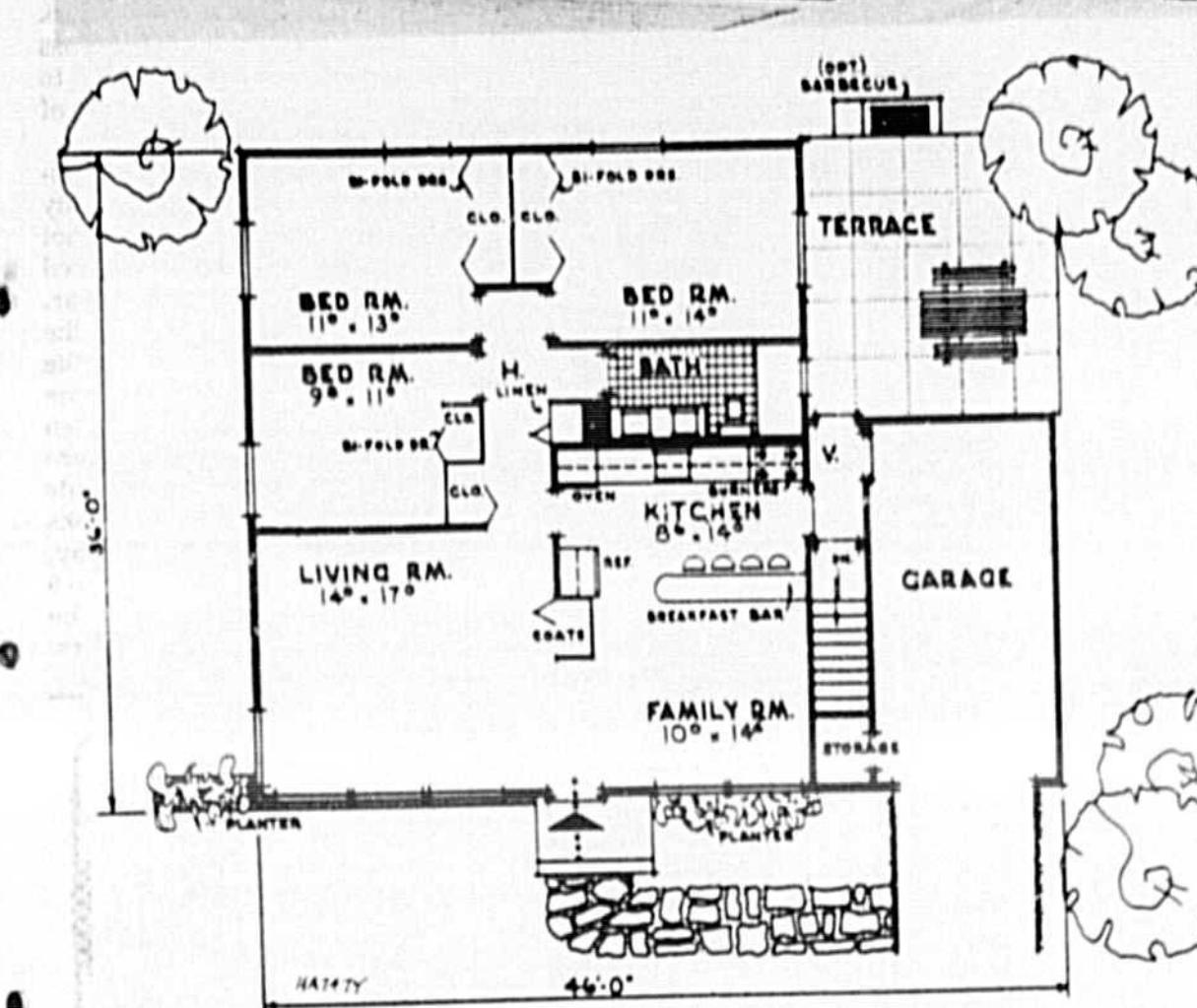
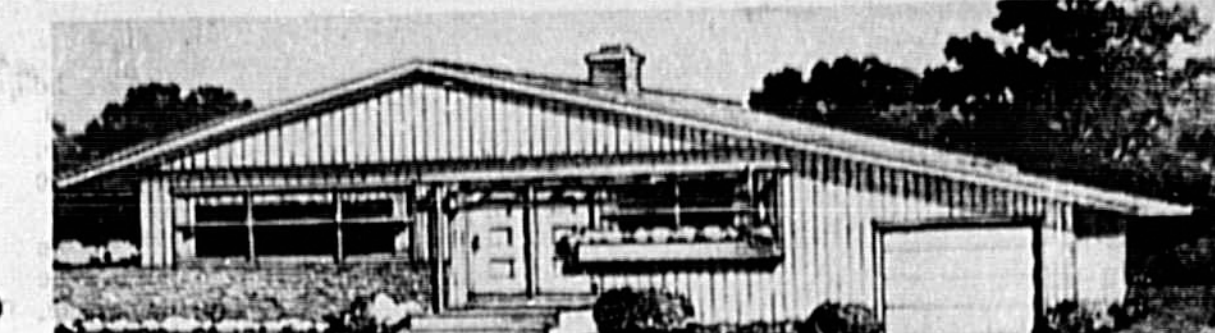

THE SLEEK EXTERIOR of this home shows vertically grooved plywood siding and a touch of brick veneer. The brick sweeps past the end of the building to form a planter and give visual length to the building. When one enters, an impression of space and openness is formed with living room, family room and kitchen all coming into view. A large breakfast kitchen and garage. The plumbing is grouped for maximum economy. Besides the coat closet, there is a spare closet in the hall leading to the bedrooms, for hard-to-store items such as the vacuum cleaner. Bedrooms are located at the rear of the house, away from street noise. Bedrooms are located at the rear of the house, away from street noise. Bedrooms are located at the rear of the house, away from street noise.

Here's How

By VIVIAN BROWN
AP Newsfeatures Writer

High city rents have motivated many career women to move to suburban areas where they have bought little houses in anticipation of their eventual retirement. In addition to enjoying the quiet life, they hope to pay off their houses before retirement. In addition to enjoying the quiet life, they hope to pay off their houses before retirement.

A career woman who moves to a little house she must maintain might find running it a bit troublesome. That has been the experience of one working girl. She had been thinking open on a cold day and the sink pipe bursts, you are inviting lots of problem and expense.

This career woman asked neighbors to water her plants when she took a winter vacation.

WATER in the cellar. She had had too and regrets that she didn't have enough sense to pump it out in a rainy season. Fortunately she didn't walk into it and throw the light switch, she says. She has learned that it could have been fatal.

A career woman who must be away from her home for long intervals must get acquainted with neighbors, she advises. Many girls leave for work early in the morning and get home late and they are likely to be too busy on weekends to be active in their suburban communities. But neighbors can be an invaluable source of assistance and comfort. A bullwark against discouragement one might feel as the result of various emergencies.

Expansion In Works For S&Ls

By CARL W. RITTER
Copley News Service

The Federal Home Loan Bank Board is pursuing a policy that is likely to result in savings and loan associations establishing many more branches, faster than in the past, and for a lot less money in the way of inflation.

These will be automated teller facilities, satellite offices and so-called limited facility branches.

What the board would like to see is many, many inns in the savings-loan industry.

FHLLB director Thomas H. Clarke says newly approved regulations will permit convenient, timesaving mini-operations.

"The limited facility scales down branches to fit into rural areas, then turns it down to fit into urban markets," Clarke said. "Both sparse populations and dense populations are best served by small facilities."

One kind of satellite, Clarke said, would be little more than a counter in a store, with a teller on hand. A more advanced satellite would be fully automated. "The key to their growth is the new breed of electronic data processing technology that will transform the financial transactions in this country—the electronic funds transfer system," Clarke said.

He also said that a new regulation allowing S&Ls to make private placements of subordinated debentures could be only weeks off.

"We are working hard on subordinated debentures," Clarke said.

He declined to go into detail because it is so near. He did "hazard a guess" that the minimum amounts of \$100,000. He said there would be many limitations on them.

The FHLLB is concerned about possible effects they could have on the Federal Deposit Insurance Corporation if debentures are not paid when they are due, even though they are subordinated," Clarke said.

He declined to go into detail because it is so near. He did "hazard a guess" that the minimum amounts of \$100,000. He said there would be many limitations on them.

ON THE HOUSE

By ANDY LANG
AP Newsfeatures

THE PRODUCT — A magnetic level that holds fast to metal surfaces.

The manufacturer's claim — "That the level has a lightweight extruded aluminum body with precision machined end caps that a magnetic strip is embedded in the full length of the level to give a firm hold on metal that the three vials for level and plumb readings have acrylic covers for added protection and that the vials and covers are so constructed that if they are damaged, they can be replaced without reworking the level to factory or service shop for repair."

THE PRODUCT — A two-speed belt sander with a dustless attachment.

The manufacturer's claim — "That the motor is between the pulleys to assure smooth sanding without digging or gouging that the unit has a selection of high speed fast material rental or low speed for better control and smoothing (finishing that the sander operates at 1200 sanding feet per minute and weighs just 9 pounds and that sanding dust is forced by the motor into a large collection bag that cleanses easily for material disposal."

THE PRODUCT — A mobile home tie-down system that can be power-actuated into the ground.

The manufacturer's claim — "That, while most other tie-down devices must be buried in the ground with a one-inch power drill, this one is driven into the ground with a 3/8-inch power drill, it is designed for 50 to 70-foot homes, although the company makes other anchor systems for smaller mobile homes... that it is especially adaptable to rocky terrain... and that it meets or exceeds known state ordinances and codes."

Baby It's Cool Inside

You Too Can Have A Cool Igloo...
Install a CARRIER Central Air Conditioning System. FREE ESTIMATES.

CARRIER

SOUTHERN AIR
OF SANFORD, INC.
106 N. MAPLE AVE.
PHONE 322-8121

NEW AUTO LOANS

We Invite You To Compare Our Lower Payments and Annual Percentage Rates

FLORIDA STATE BANK
SANFORD, FLORIDA
MEMBER F.D.I.C.

Sanford, Fla. Dial 322-1411 & Ask for Mickey Hickson or Ralph Peck



NEW TEACHERS joining faculty at Longwood Elementary School this fall include Joan Shalls (seated), Lynn Shad, Margaret Jarrell, and Linda Couney. (Ann Riley Photo)

Hot Spot

Camels carry visitors over lava-eroded slopes that may nuzzle at 700 degrees only two feet below the surface on Lanzarote, easternmost of the Canary Islands.

Christmas Cards
with decorated envelopes

This year's cards from the Drawing Board, Inc. are the finest yet — a feast of color and one-of-a-kind designs. This fresh collection brings a variety of designs with Christmas decorated envelopes.

It's wise to order early. And, we'll personalize each card for you. Your satisfaction is guaranteed. Card size is 6 1/2" x 9 1/2".

50 cards \$5.00 without name imprint
with one line imprinted 50 cards \$7.50
with two lines imprinted 50 cards \$8.50

Also available in smaller or larger quantities.

george stuart
133 East Robinson, Orlando, Fla.

COMET AWNINGS

CHOICE OF COLORS ALL ALUMINUM BAKED ENAMEL **40% off**

WITH PURCHASE OF 3 OR MORE FENCE, AWNING & CARPET OF SANFORD, INC.

UNITED
PHONE 322-3434
2512 S. PARK DR. SANFORD

SANFORD Sears Kenmore Washer and Dryer Value Spectacular!

3-DAY SALE!

Automatic Washer \$149.95*
2 Temperature Dryer \$89.95*
4-Cycle, 2-Speed Washer \$199.88*
Fabric Master Dryer \$129.88*

BUY BOTH for only \$239.90*
BUY BOTH for only \$329.76*

Use Sears Easy Payment Plan

PLUS MANY UNADVERTISED SPECIALS... DEMONSTRATORS... DISPLAY MODELS

SHOP AT SEARS AND SAVE Satisfaction Guaranteed or Your Money Back

Sears
PINECREST CENTER HWY. 17-92 AT 27th SANFORD, PH. 222-1771

THESE SPECIAL PRICES GOOD THRU SAT. OCT. 7 AT SANFORD ONLY OPEN THURS. & FRI. TIL 7 P.M.

DISNEY WORLD BUS TOURS AVAILABLE DAILY

WORLD ALMANAC FACTS

The first section of the New York City subway began service from City Hall to 145th Street, Oct. 27, 1904. The World Almanac says, in 1970 the New York subway system had 237 miles of main track and transported 1,258 billion passengers compared to a 1947 peak of 2,051 billion passengers.

CHICKEN LUNCH?

"It's Money Dipped"

WHERE THE FUN NEVER SETS

JOLLY ROGER

FORT LAUDERDALE THE FUN HOTEL ON THE OCEAN

2 Pcs. Chicken Cole Slaw Hot Biscuit & Honey **86¢**

Famous Recipe FRIED CHICKEN

OPEN DAILY 11 A.M. TIL 9 P.M. FRI. & SAT. TIL 10 P.M. 1809 French Ave. (Hi-way 17-92) Sanford

RENT \$10 a month

A ROYAL DIGITAL ELECTRONIC CALCULATOR and apply major part to purchase

george stuart
133 East Robinson - Orlando, Florida
Phone: (Orlando) 322-8121

Confused about electronic calculator prices, and claims? Don't be fooled by all the price-cutting ads by shopping centers, cut-rate stores, mail-order and catalog houses, or unknown brands. Deal with an authorized office equipment dealer who has been in business for a generation, who sells quality products and gives you a choice of makes and models... and will back up what he sells.

RENT a brand new Royal Electronic Calculator — a basic electronic model that adds, subtracts, multiplies and divides. It has automatic fixed decimals. This ten column machine is easy to carry... it weighs only 3 3/4 lbs. It is small, too. Takes up less space on your desk than an ordinary letterhead... 7 1/2" wide by 10 1/2" deep... and it's only 3" high.

Made by Royal Typewriter Company, a division of Litton Industries, the Royal Electronic Calculator is sold by George Stuart — Florida's Largest Business Supply Department Store — in business since 1928. These machines formerly sold for \$249.95. Our new low "floor price" is \$124.25 while they last. RENT the machine for only \$10 a month. Keep it as long as you like. Apply 85 per cent of the rental paid toward the purchase price at any time you like... or return it with no obligations. No iron-clad lease. No minimum charge except current month's rental. You pay only one month's rental in advance. No service charges — we will repair or replace these rental machines without charge when brought to our office.

Scores of other models of electronic calculators for rent or sale at the lowest prices any place!

CHECK WITH george stuart

Sterchi's OVER 250 SOFAS OVERSTOCK SELLOUT!

- ★ THERE'S NEVER A CHARGE FOR DELIVERY WITHIN 100 MILES!
- ★ WE SERVICE WHAT WE SELL!
- ★ THERE'S NEVER A SET-UP CHARGE ON FURNITURE OR APPLIANCES!
- ★ CONVENIENT TERMS ARRANGED TO FIT YOUR BUDGET!
- ★ THE SALE IS NEVER COMPLETE UNTIL YOU ARE SATISFIED!
- ★ NO FINANCE COMPANY TO DEAL WITH... WE FINANCE OUR OWN ACCOUNTS!

- ★ Choose from a wide selection of styles and colors priced specially for this great sale!
- ★ Shop all stores... all items not at all stores!
- ★ Many matching or correlated chairs reduced at similar savings for this sale!



FRENCH PROVINCIAL SOFA BY SOUTHERN Covered in light beige textured print fabric. Reg. \$229.95 Sale \$198	HIGHLAND HOUSE LAWSON TRADITIONAL 3 CUSHION SOFA With tight back covered in red, blue, and beige flower design linen print. Reg. \$419.95 Sale \$329	PINNACLE TRADITIONAL TUXEDO ARM SOFA With 2 seat cushions and 4 back cushions covered in bright beige, red and green flower print linen fabric. Reg. \$339.95 Sale \$294	TRADITIONAL TUFTED BACK AND ARM SOFA With 3 loose seat cushions covered in rose, beige, gold print fabric. Reg. \$569.95 Sale \$464
TRADITIONAL SOFA BY PINNACLE With tuxedo arms, loose seat and back cushions, covered in celery green fabric. Reg. \$319.95 Sale \$279	TRADITIONAL 3 CUSHION SOFA Tufted back, tuxedo arm covered in light gold velvet by Highland House. Reg. \$599.95 Sale \$529	CONTEMPORARY SOFA FAMOUS MAKE With high tuxedo arms richly tufted on back and arms, with 3 loose foam seat cushions covered in bright gold velvet. Reg. \$279.95 Sale \$234	MODERN SOFA With tufted back and seat, with tuxedo arms, covered in beige soft velvet. By Kroehler. Reg. \$349.95 Sale \$279
2-PIECE CONTEMPORARY SECTIONAL SOFA BY SOUTHERN Covered in beige velvet. Reg. \$499.95 Sale \$399	TRADITIONAL SOFA KROEHLER TUXEDO With 3 loose cushions and tufted back, covered with teal green fabric. Reg. \$419.95 Sale \$349	MODERN 3 CUSHION SOFA BY SOUTHERN With 3 loose backs and chrome legs. Covered in striking black vinyl. Reg. \$349.95 Sale \$279	MODERN STOUT ARM TUFTED SOFA Back and arms with 2 loose reversible seat cushions covered in light blue fabric. Reg. \$399.95 Sale \$288
TRADITIONAL SOFA BY HIGHLAND HOUSE With 2 large foam cushions, rolled tufted back covered in gold velvet. Reg. \$589.95 Sale \$469	3 CUSHION SOFA TRADITIONAL By Highland House with tufted back and high tuxedo arms. Covered in light textured white print. Reg. \$469.95 Sale \$418	100" TRADITIONAL HIGH ARM SOFA With tufted back and arms - 3 foam seat cushions covered in rich gold velvet. Reg. \$319.95 Sale \$269	COLONIAL STYLE SOFA With maple wood trim covered in beige, gold, red and green Colonial print linen cover. Reg. \$239.95 Sale \$198
SPANISH SOFA BY FAMOUS MANUFACTURER With loose seat and back cushions covered with celery green crushed velvet with correlated print on one side of cushions. Reg. \$329.95 Sale \$269	TRADITIONAL SOFA FAMOUS MAKE Attached back cushions, 3 loose foam seat cushions, Lawson arm, 2 bolster cushions covered in beige, green, yellow and gold linen flower print fabric. Reg. \$249.95 Sale \$219	TRADITIONAL SOFA HIGHLAND HOUSE With 4 loose back and seat cushions covered in beige, gold and green stripe velvet. Reg. \$549.95 Sale \$468	COLONIAL SOFA With dark maple wings and arm knuckles covered in green, black, and gold plaid Herculon. Reg. \$319.95 Sale \$264
TUXEDO ARM TRADITIONAL SOFA BY HIGHLAND HOUSE With 3 loose foam cushion seat and back. Covered in gold and green long weaving fabric. Reg. \$619.95 Sale \$529	PINNACLE SPANISH TRADITIONAL SOFA 3 loose seat and back foam cushions with tuxedo arms. Covered in avocado green chenille velvet with contrasting print on one side of cushions. Reg. \$329.95 Sale \$269	TIGHT BACK SOFA TRADITIONAL With 3 loose foam seat cushions covered in green and red tone print fabric. Completely quilted. By Highland House. Reg. \$439.95 Sale \$349	100" SPANISH SOFA With dark wood trim on side of arms, tufted back and 3 large loose cushions covered in Spanish red and dark green fabric. Reg. \$299.95 Sale \$248
CONTEMPORARY SOFA FAMOUS MAKE With tuxedo arms, 3 foam seat cushions covered in beautiful blue print with contrasting royal blue weaving. Reg. \$279.95 Sale \$238	88" MODERN SOFA With loose back and seat cushions covered in bright beige, white, tan and black stripe velvet. Has chrome trim on arms with castor base. By Southern. Reg. \$429.95 Sale \$359	CONTEMPORARY SOFA FAMOUS MAKE With 3 loose back and seat cushions covered in bright yellow gold fabric. Reg. \$499.95 Sale \$438	COLONIAL SOFA With maple trim on wings and arm knuckles covered in gold-green tweed for long wear. Reg. \$249.95 Sale \$188
90" TRADITIONAL SOFA BY SOUTHERN With loose back and seat foam cushions. Covered in gold wide ribbed velvet. Reg. \$329.95 Sale \$268	TRADITIONAL 3 FOAM CUSHION SOFA With attached tufted back, has quilted green, beige, gold and blue print fabric by Southern. Reg. \$299.95 Sale \$229	TRADITIONAL SOFA With 3 loose back and seat cushion and 2 bolsters covered in beautiful rust smoke gold-green-beige cut velvet, by Highland House. Reg. \$519.95 Sale \$449	SPANISH 102" SOFA With tufted seat and back with tuxedo arms covered in antique gold velvet. Reg. \$269.95 Sale \$198

SEE OUR COMPLETE SELECTION OF FURNISHINGS FOR MOBILE HOMES OR SMALL APARTMENTS!

Coming Soon... A NEW STERCHI'S IN Ocala, FLA.

OPEN DAILY 9:30 TO 5:30 FRIDAY UNTIL 9 P.M.

AVAILABLE IN LAKELAND LEEBURG ORLANDO

1100 FRENCH AVE. SANFORD

SINCE 1888 **Sterchi's** THE SOUTH'S LARGEST QUALITY HOME FURNISHERS

Here comes Penney Days. And here goes 15% off all our dress shirts for men.

The very special knit look. Very specially priced during Penney Days.

Supplement to SANFORD HERALD, Tuesday, October 3, 1972, Sanford, Florida

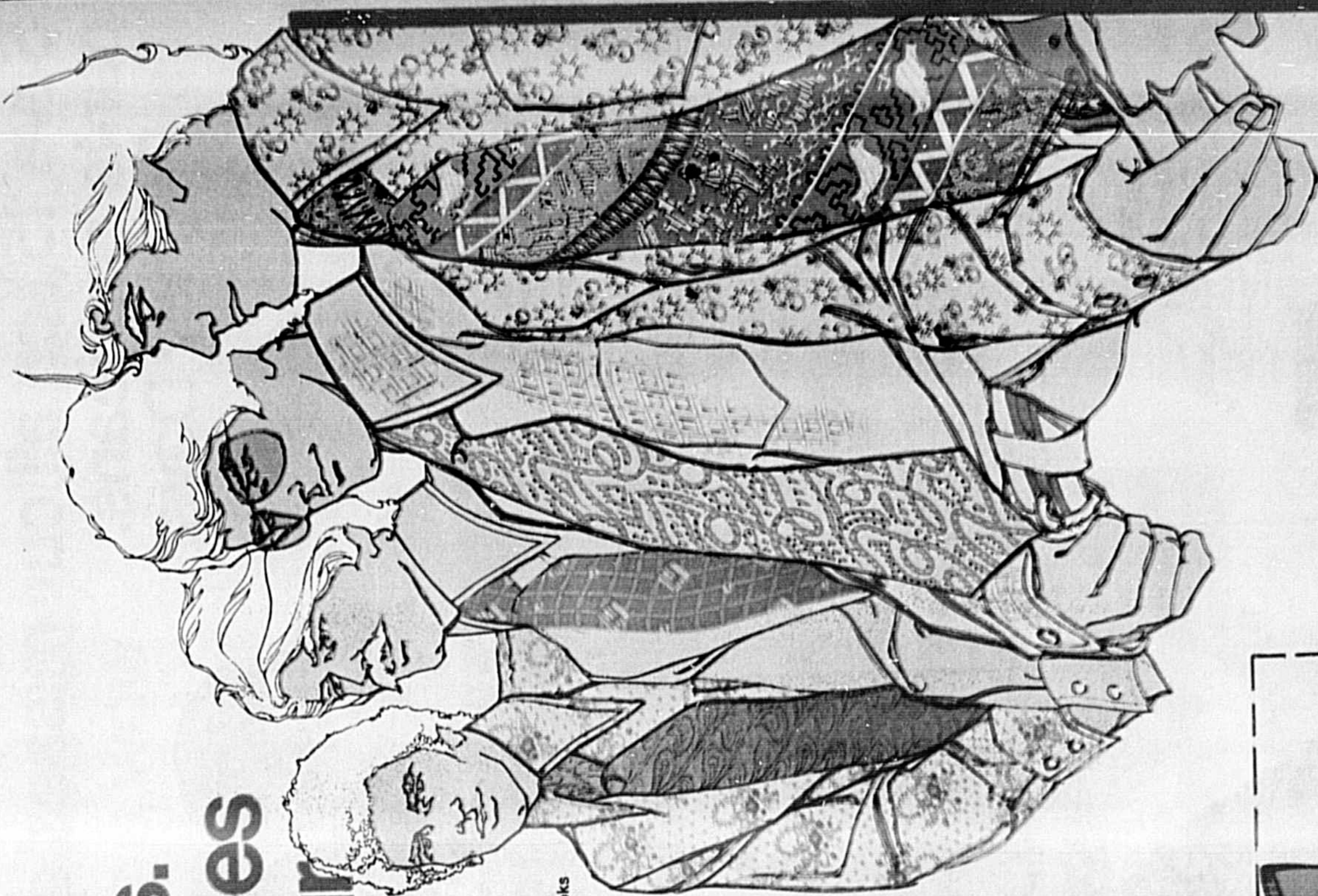

Knits and newer line blends. Long and short sleeves. Fashion looks at great colors and prints. Sizes 14 1/2 to 17. All priced at 15% off thru Saturday.

Sale \$5
Reg. \$8 print shirts of polyester/cotton, textured for comfort. 2-button cuffs.

Sale \$5
Reg. \$8 polyester/cotton shirts, textured to stretch when you do. Great colors and prints. Sizes 14 1/2 to 17. All priced at 15% off thru Saturday.

Sale \$5
Reg. \$8 navy knit shirt of wrinkle-free polyester/tricot. 2-button cuffs. Reg. \$7... Sale \$7.75

Sale \$5
Reg. \$8 white on white polyester/cotton shirt that's Penn-Prest so you never iron. Short sleeves. Reg. \$5... Sale \$4.25

Sale \$6.50
Reg. \$10 long sleeve, wrinkle-free polyester/tricot. 2-button cuffs. Reg. \$7... Sale \$7.75

Ties Galore! 350
A handsome selection of polyester ties in traditional and fashion colors. Solids, stripes, and fancies. Sizes 6 to 18.

Special 3.99
Boys' short sleeve, long neck sport shirts in fashion colors. Sizes 6 to 18.

Special 7.74
Kissed cheeks, sunny smiles, and a happy mood. Suntan, coffee bean, jet brown or gaila. Sizes: A and B.

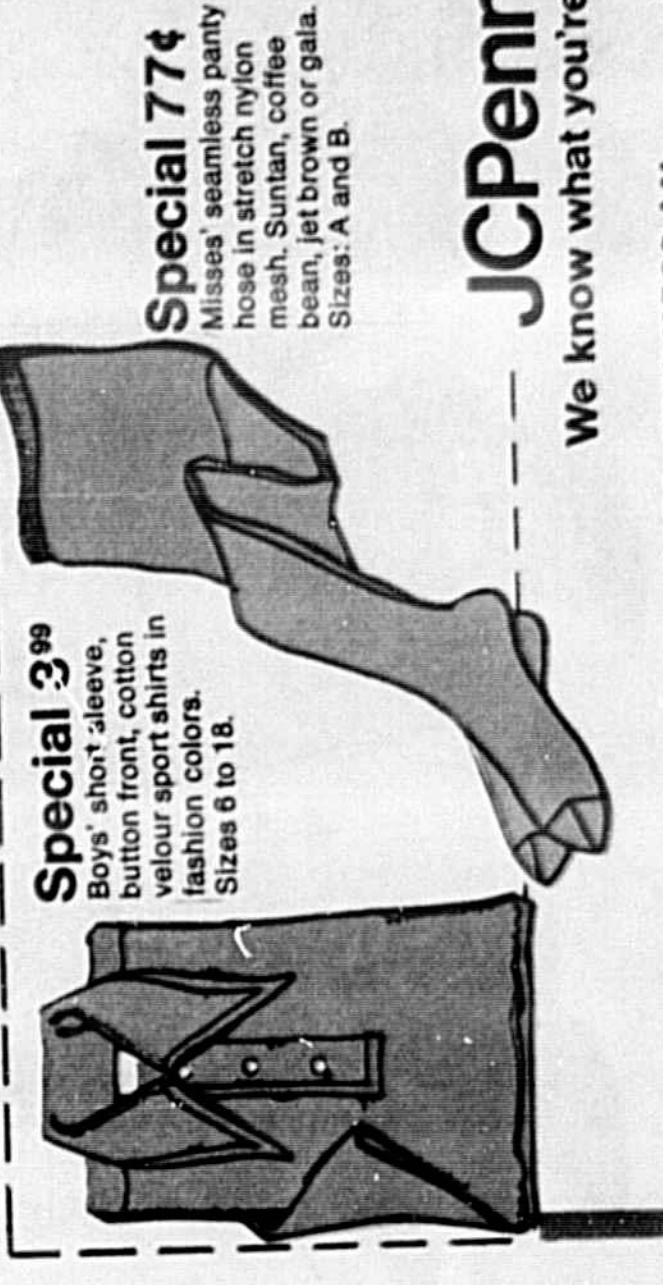

JCPenney
We know what you're looking for.
STARTS WEDNESDAY, OCTOBER 4
SANFORD, FLORIDA
SANFORD PLAZA
10:00 AM TIL 9:00 PM
MONDAY-SATURDAY

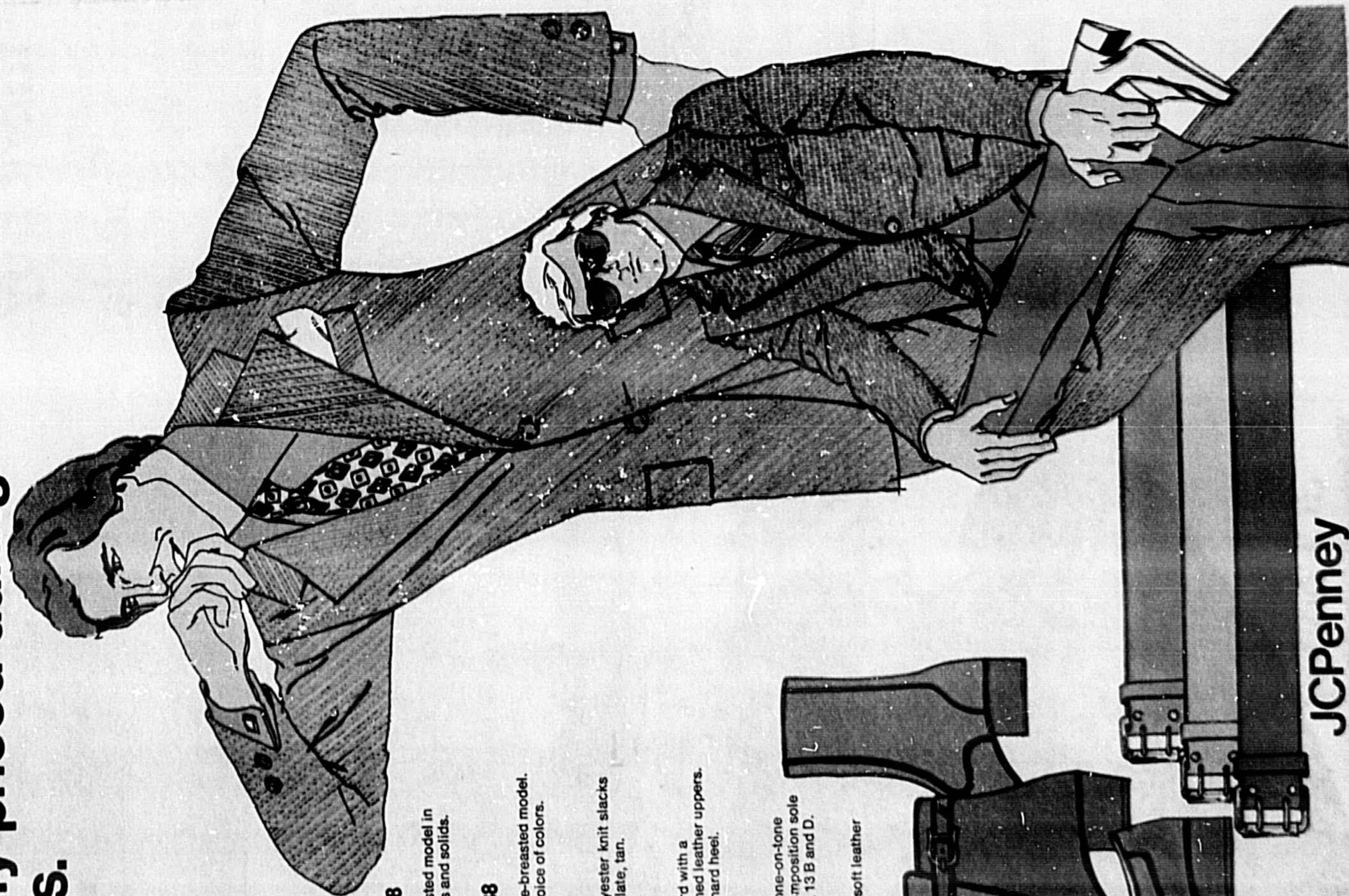

Special 49.88
Polyester knit suit. Single-breasted model in grey, brown, blue, olive, fancies and solids. Regular, short, long.

Special 24.88
Polyester knit sport coat. Single-breasted model. Solids and fancies in a wide choice of colors. Regular, short, long.

Special 8.99
Polyester knit slacks in solid navy, burgundy, chocolate, tan. Waist sizes 30 to 42.

14.99
Two-tone fashion oxford with a higher heel. Smooth and brushed leather uppers. Composition rubber sole and hard heel. Sizes 6 1/2 to 13 B and D.

16.99
7-7 panel boot in soft, tone-on-tone leather. Nylon tricot lining. Composition rubber sole and hard heel. Sizes 6 1/2 to 13 B and D.

18.99
7-7 dress boot in glove-soft leather and crinkle patent leather. Composition rubber sole and hard heel. Many sizes.

3.50
Men's fashion belts in great selection of colors.

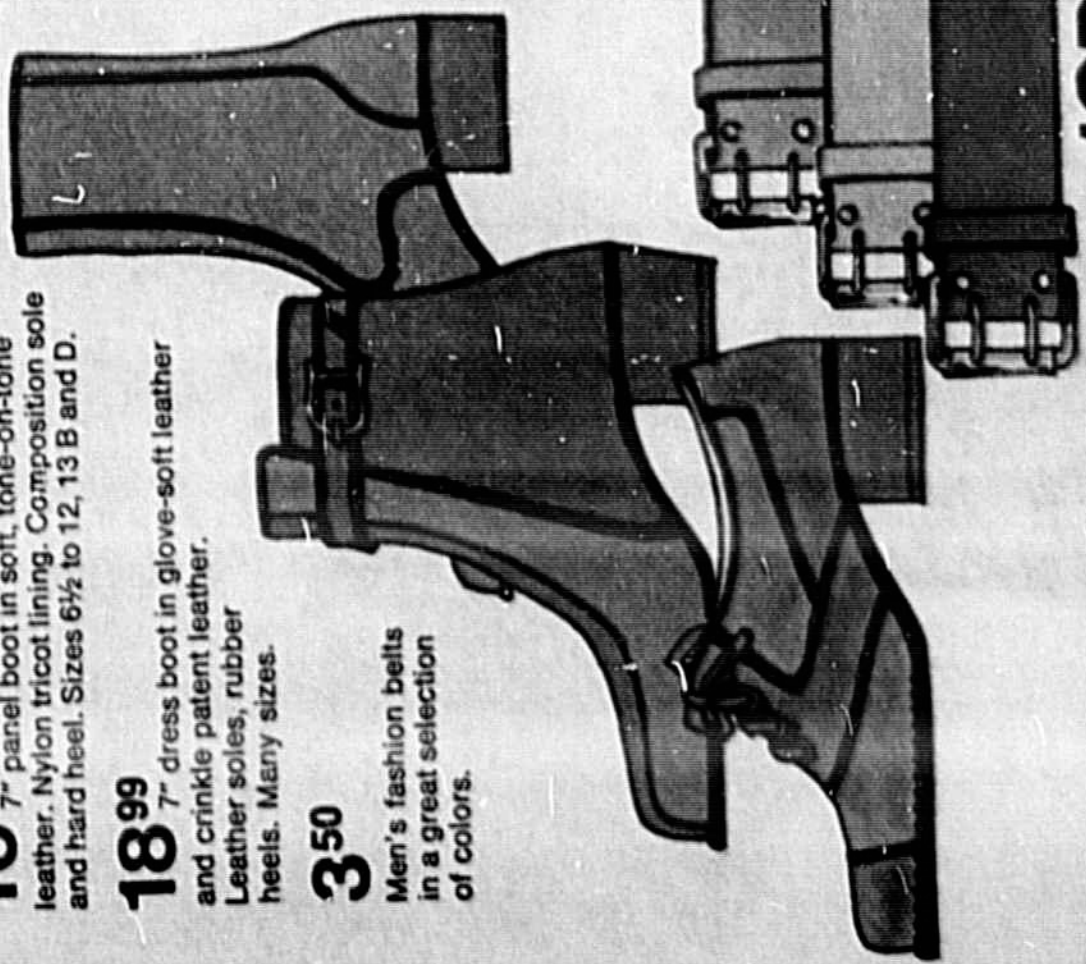

JCPenney
We know what you're looking for.

such as film-called but del-ed and weeks, course by and but At- Hawk about es. I holds ether, I ay all concepts ion and

nesses: rcent that called propos e Mary sh the of Lake

the new ould en- or. Sub- stituted that be ex- me local ting, "It e us as " rose by me south 'ether it s against ar to live for ad. to Mrs. 'hanber ur to live operation l. Notice o be filed months will be vote. iggerated proposed let were e Chan-

it n its

la. (AP) rs will be l to pay excess of arms and et Shevin

that date i of a de- became y will also is. requires per cent l deposit nt of the posts are

between egulating a. Shevin ile home posts ex- Parte, D- urther the sevin said

INC

such as film-called not del-and weeks. course gy and 'but At- Hawk's about es. I holds ether," they all concepta ion and

nesses," renbelt called proposed a Mary sh the of Lake

the new mid- en- or. Sub- ited that be ex- local ting. "It as as rose by ne south hether it against wait for od. to Mrs. hamber at a five poration I. Notice e filed months will be vote. iggered roposed at were e Cham-

it n its

la. (AP) rs will be 1 to pay excess of ones and rt Shevin

that date of a det- become y will also is. requires per cent deposit nt of the posts are

between egulating n. Shevin ile home posts ex- Parte, D- ither the hevin said

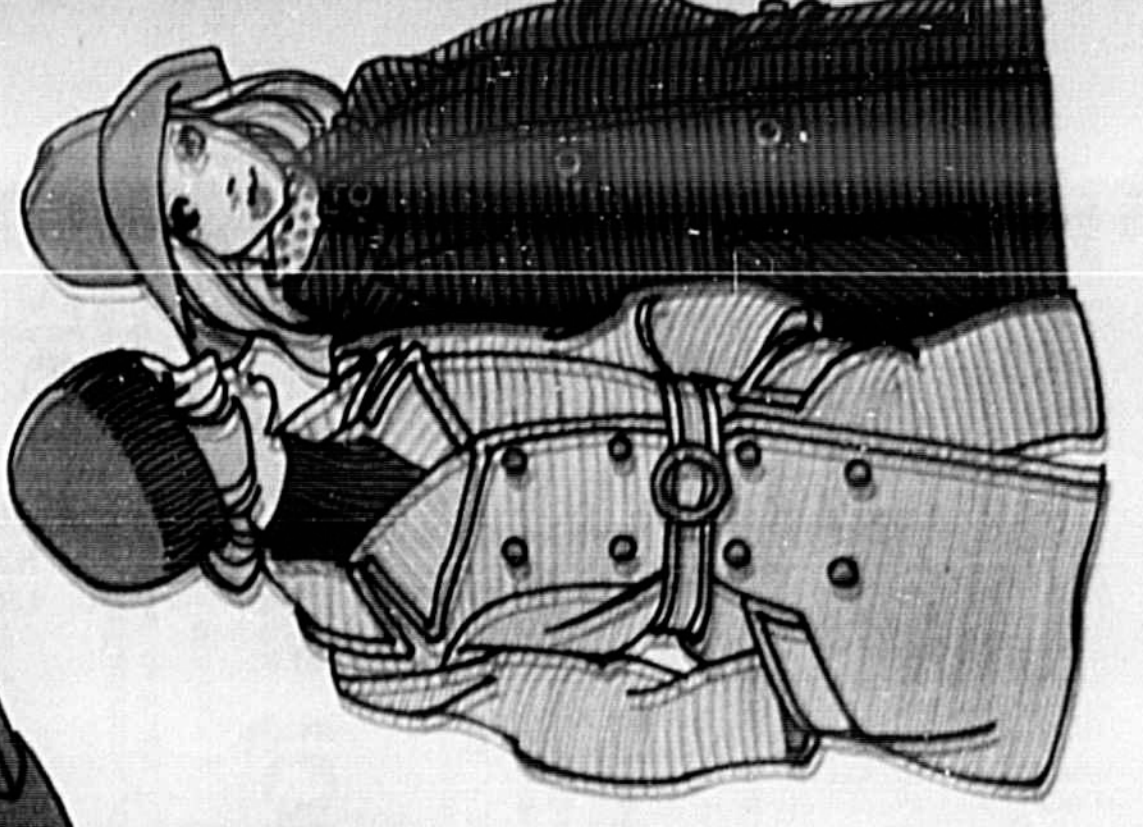

Special 168
 Classy cords. Hefty wide wale cotton corduroy double breasted with button, belt, and pocket detail. For pants, long or short skirts. Winter shades. 10 to 18.

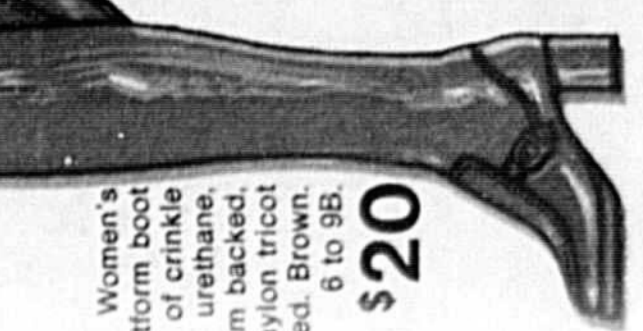

9.99
 Women's slipper boot in soft, unlined, synthetic, urethane, nylon tricot lined. Brown, black, white. 6 to 9B.

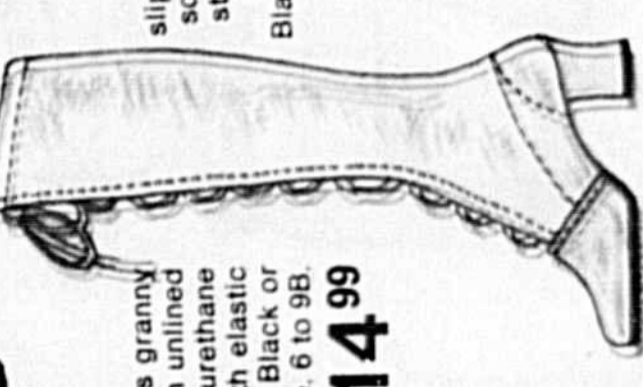

14.99
 Women's granny boot with elastic laces. Black or white. 6 to 9B.



Special 178
 Ribbed polyester top with dotted sleeves. Cuffed trousers of polyester. Black/red, black/white, beige/red. Black. 10 to 18.

Combine the layered-look with new trouser-pants for a wow of a Penney Days buy!

Save 15% on all our misses' and juniors' pants and jeans. It's Penney Days.

Sale 722
 Reg. \$50. Boy-cut brushed cotton denim jeans with flare legs. Many colors to choose from. Junior sizes 3 to 15.

Sale 935
 Reg. \$11. Double-knit polyester pull-on pants. Navy, purple, red and white. Black, blue. Misses' proportioned-to-fit sizes 8 to 20.

Sale 425
 Reg. \$5. Cotton denim jeans with snap front fly, belt loops, flare legs. Assorted colors. Junior sizes 3 to 15. Sale prices effective thru Saturday, Oct. 7th.

Special 399
 Cotton/polyester knit shirt, henley, button-down. Sizes 8, 10, 12, 14, 16, 18, 20.

Special 799
 Screen print cardigans of double-knit polyester. Many fashion prints to choose from. Sizes 40 to 46.



Special 884
 Opague nylon knee-highs with cuff top. White, navy, chocolate, red, white, green, gold. One size fits 8 to 11.



JCPenney
 We know what you're looking for.

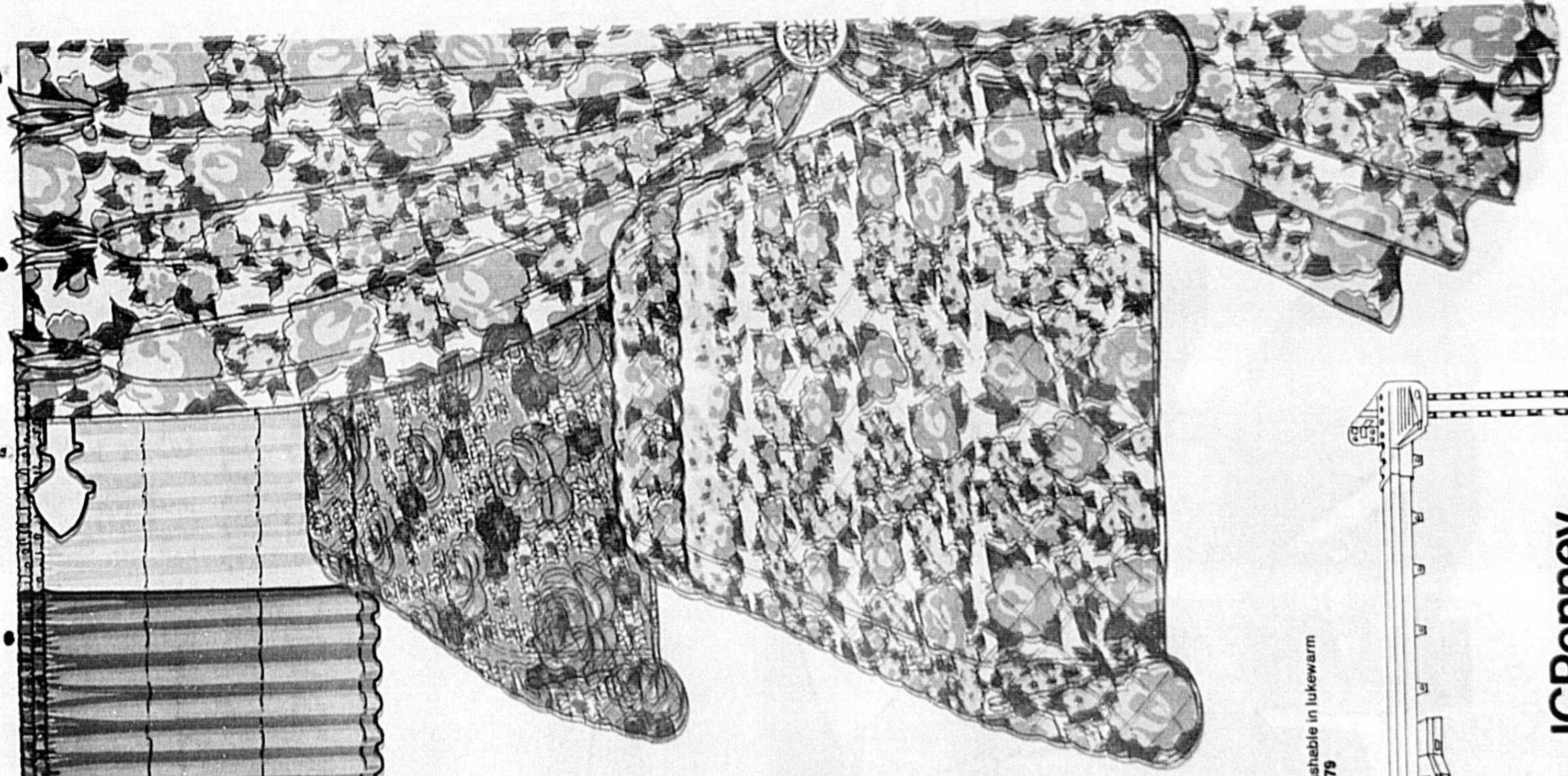

Save 15% on all our quilted bedspreads during dollar-saving Penney Days.

Sale 1275
 Reg. \$15. Flower Garden throw-style polyester/cotton spread with polyester fibrill. Gold or pink. Sale prices effective thru Saturday, Oct. 7th.

Sale 935
 Reg. \$10.25. Queen throw-style quilted acetate with polyester fibrill. Gold, pink, blue. Queen and king sizes, reg. 17.99. Sale 15.30. Matching acetate table draperies: 48" x 60" and 84" x 56. 72 x 84. Sale prices effective thru Saturday, Oct. 7th.

249
 Reg. \$249. "Marselles" Dacron polyester rayon panels are machine washable in lukewarm water. Your choice of white and fashion colors. 52x61. Sale prices effective thru Saturday, Oct. 7th.

Adjustable modern traverse rods:
 Fits 30 to 48" ... \$4.99
 Fits 48 to 66" ... \$7.29
 Fits 66 to 150" ... \$9.49

JCPenney
 We know what you're looking for.

The way to a whole new wardrobe. Our Penney Days fabric buys.

Special 166
 YD. Ribbed corduroy. Everybody's favorite sportswear fabric. 100% cotton and machine washable. Fall colors. 45/46".

Special 199
 YD. Polyester doubleknit! Trenchcut in crepe, plaid, and jacquard patterns. Lots of fashion colors. 60" wide.

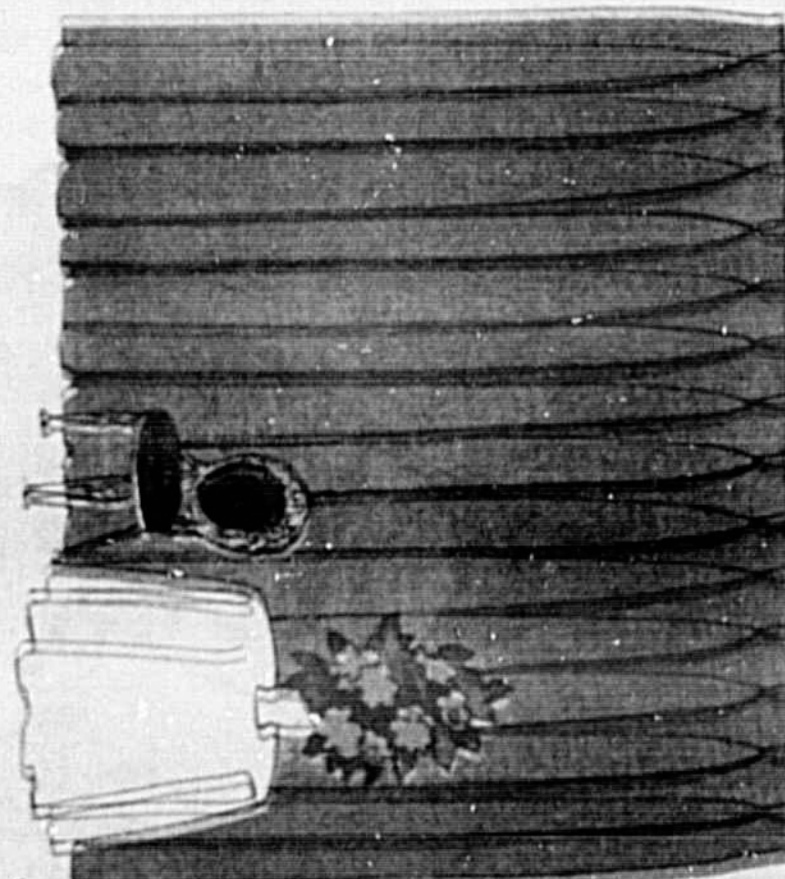

Special 744
 788. Border design of rayon/cotton with thermal foam acrylic backing. Penn-Press for easy care, no ironing. Madras, moss or gold.



JCPenney
 We know what you're looking for.

★ ★ ★ ★ ★

FRENCH BY SOU
 Covered fabric. Reg. \$

TRADITIONAL BY PIM
 With two back cur green fal. Reg. \$

2-PIECE SECTION BY SOI
 Covered. Reg. \$

TRADITIONAL BY HIG
 With 2 tufted b. Reg. \$

SPAN FAMOUS
 With lot covered velvet side of. Reg. \$

TUXEL BY HIG
 With 3 and be green lo. Reg. \$

CONTAMOUS
 With cushion print w. Reg. \$

90" BY SO
 With cushion bed vel. Reg. \$

SEE

Superman Turning Teacher?

High School Students Studying (Seriously)
Comic Book As Literature Masterpieces

DELRAY BEACH, Fla. (AP) — Captain Marvel, Thor and The Hulk are taken seriously at Atlantic Beach High School where the time-honored taboo of reading comic books in the classroom has ended.

Comic books are an integral part of a course entitled Science Fiction and the Literature of the Supernatural World taught by 36-year-old John Schiffermuller.

"The theory is that each community is different and the schools are there to meet the needs of the community," a school system spokesman said.

Remedial readers need comic books to spark their interest in other literature, Schiffermuller maintains.

"Besides, it's my favorite kind of literature," he said. "Although the course is only a few months old it already has run into opposition from parents who don't understand why their children are writing essays on Super Man."

Schiffermuller plans a course on rhetoric, demology and the occult next semester but Atlantic Principal I. Earl Hawk has some reservations about the experimental course.

The Sanford Herald

Friday, October 6, 1972—Sanford, Florida 32771
65th Year, No. 34 Price 10 Cents



By John A. Spolki

Still getting calls from Montreal, Canada... about a correction which we ran in 'The Herald'.

Clear the political air, please... If the Republicans would want us to believe that they're really for the "little guy," then how 'em they offered so much opposition to the railroad retirement, or for that matter, the bit about Consumer Protection???

Test your memory... 'bout 30 days ago I said to check the polls (if you have any faith in 'em in the first place) and watch how those "turncoat" Demos would be coming back into the fold.

For the folks at the Seminole Hospital... why come out with the salaries of all employees. However, the facts show that although the RNs and the LPNs did get a bump in their weekly paychecks, the hard-working aides didn't get penny-one!

Post Office deliveries for this Monday are on a holiday schedule, you know... cause we'll be celebrating Columbus Day on Monday the 9th instead of Thursday the 12th. Change in calendar, remember...

Let me pay a well-deserved compliment onto the 9th graders of Crooms High School in Sanford. These fellahs are so good... like almost 70 points scored last night, and in the first two games haven't yielded a single point to be scored against them.

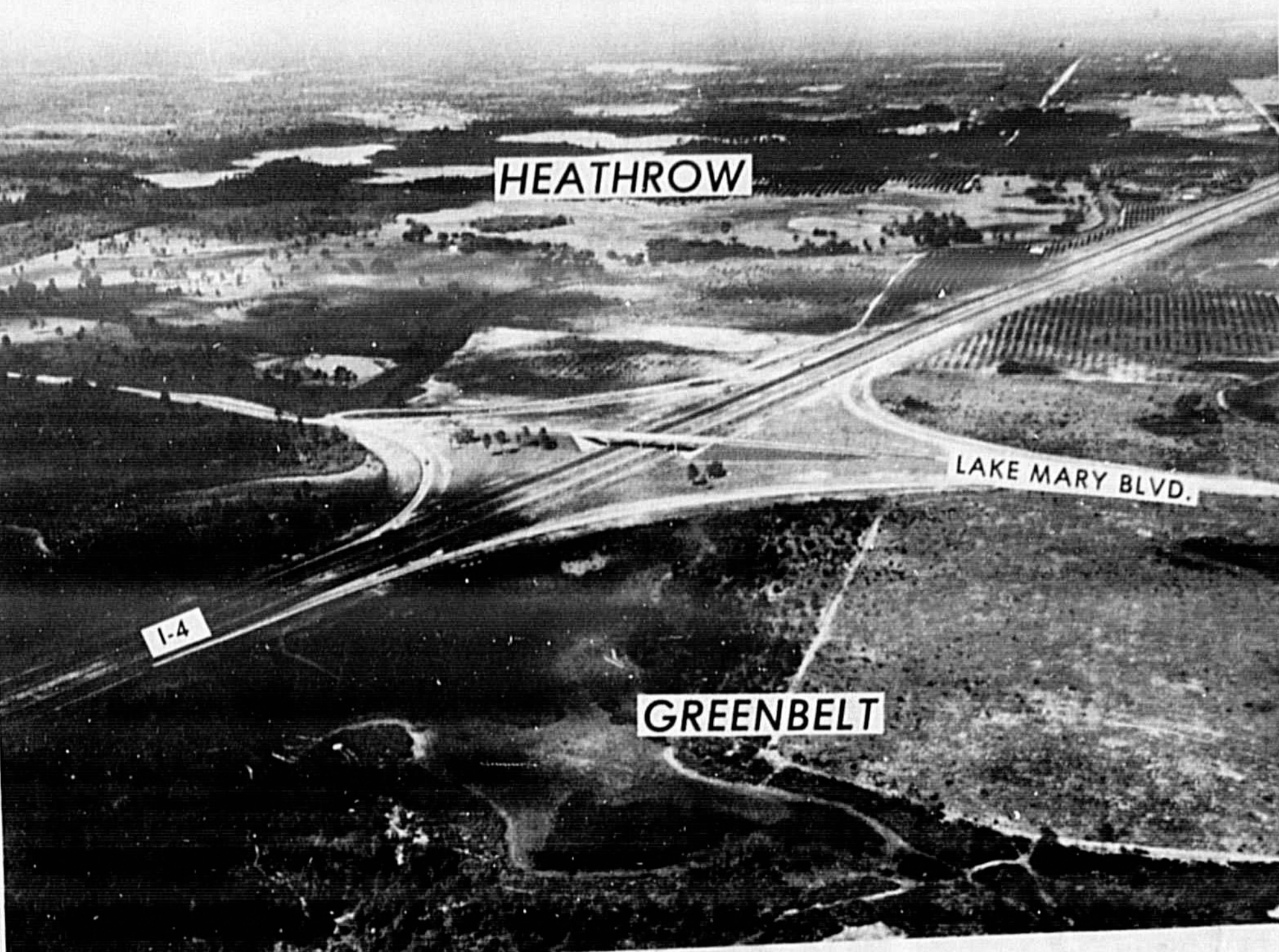

HUB OF A FUTURE MAJOR COMMUNITY

"Heathrow," being developed by Paulucci Enterprises, north, Heathrow will be located on 1,300 acres in the north half of the photo and Greenbelt, also on 1,300 acres, will be in the lower half. (Bill Vincent aerial photo)

President Pledges:

'No Tax Increase in 1973'

By THE ASSOCIATED PRESS
President Nixon pledges that "there will be no tax increase in 1973," though his aides have said that the full four years of a second Nixon term would pass without a tax hike.

Democratic challenger George McGovern says he doesn't intend to boost taxes for Americans who live solely on wages.

He promised to veto such bills and said he expects Congress to sustain the vetos.

McGovern responded, "Of course this is the Republican line. It's pure poppycock... If you live entirely on wages and salaries, there is nothing in my tax proposals that would increase your taxes."

State Law Officer Is 'Mystery Man'

By BILL SCOTT
The identity of the so-called mystery man in the Glenn Turner case was identified today as being an agent of the Florida Department of Law Enforcement, according to Gil Rodriguez, Orlando special agent.

Rodriguez called The Herald to advise it was one of his men who attempted to contact William Nasbaum, former Turner Enterprises assistant treasurer, and Antonio Lopez, former Comptroller.

Rodriguez declined to disclose the reasons behind the attempt to see the former Turner officials at their Winter Park homes but disclosed it had nothing to do with the trial of Turner about to get underway in Pinellas County.

75 NEW VW'S IN STOCK
15 Demonstrators Must Be Sold!
Only \$1999

BILL BAKER VOLKSWAGEN, INC.
NOW TWO LOCATIONS
SANFORD
2318 Hwy. 17-92 South
Orlando Ph. 444-3814

For girls only. 15% off all tops, pants and jeans during Penney Days.

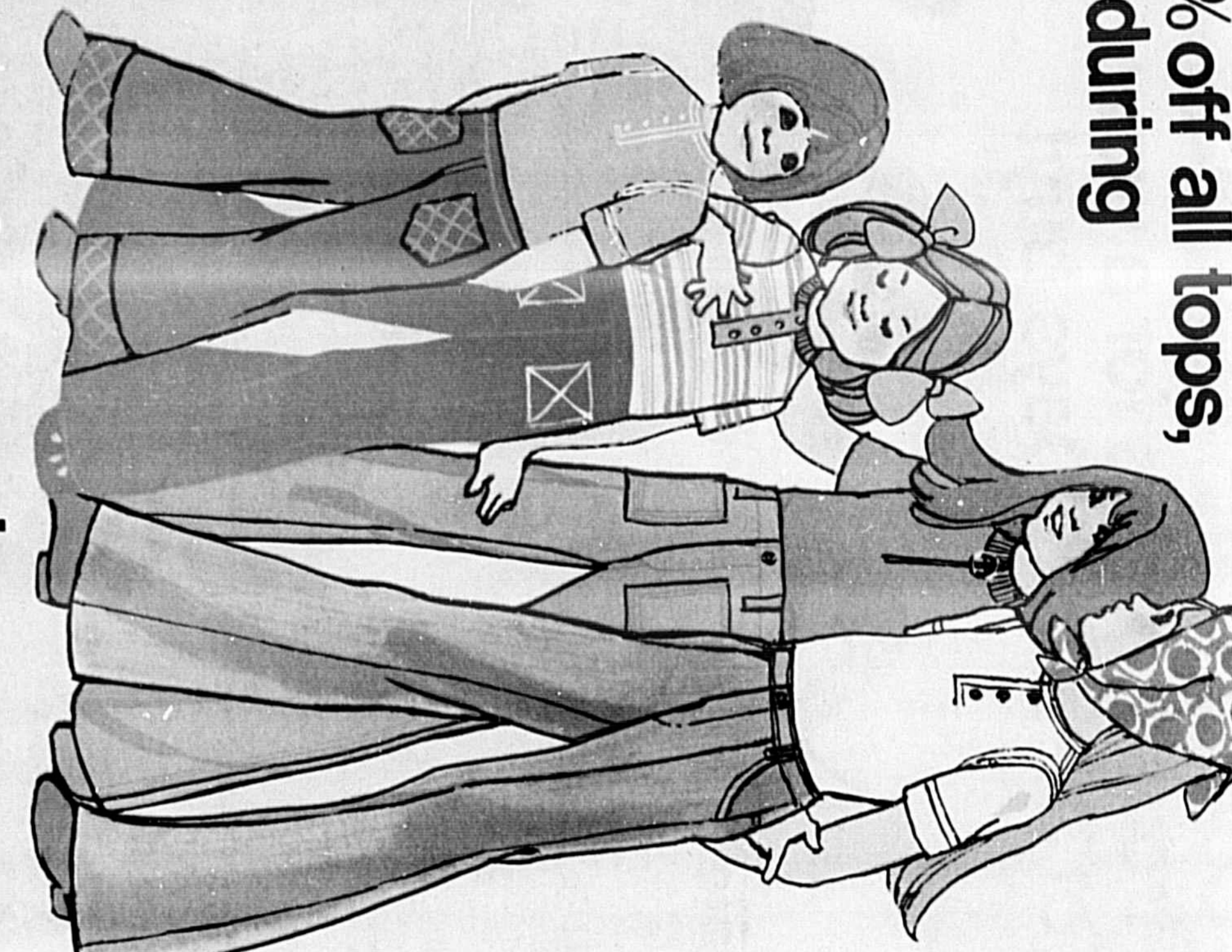

Sale 2.55

Sale 2.55

Sale 2.08

Sale 2.55

Sale 4.25

Sale 4.25

Sale 4.25

Sale 4.25

Sale 4.25

Sale 4.25

Sale 4.25

Sale 4.25

Sale 4.25

Sale 4.25

Sale 4.25

Sale 4.25

Sale 4.25

Sale 4.25

Sale 4.25

Sale 4.25

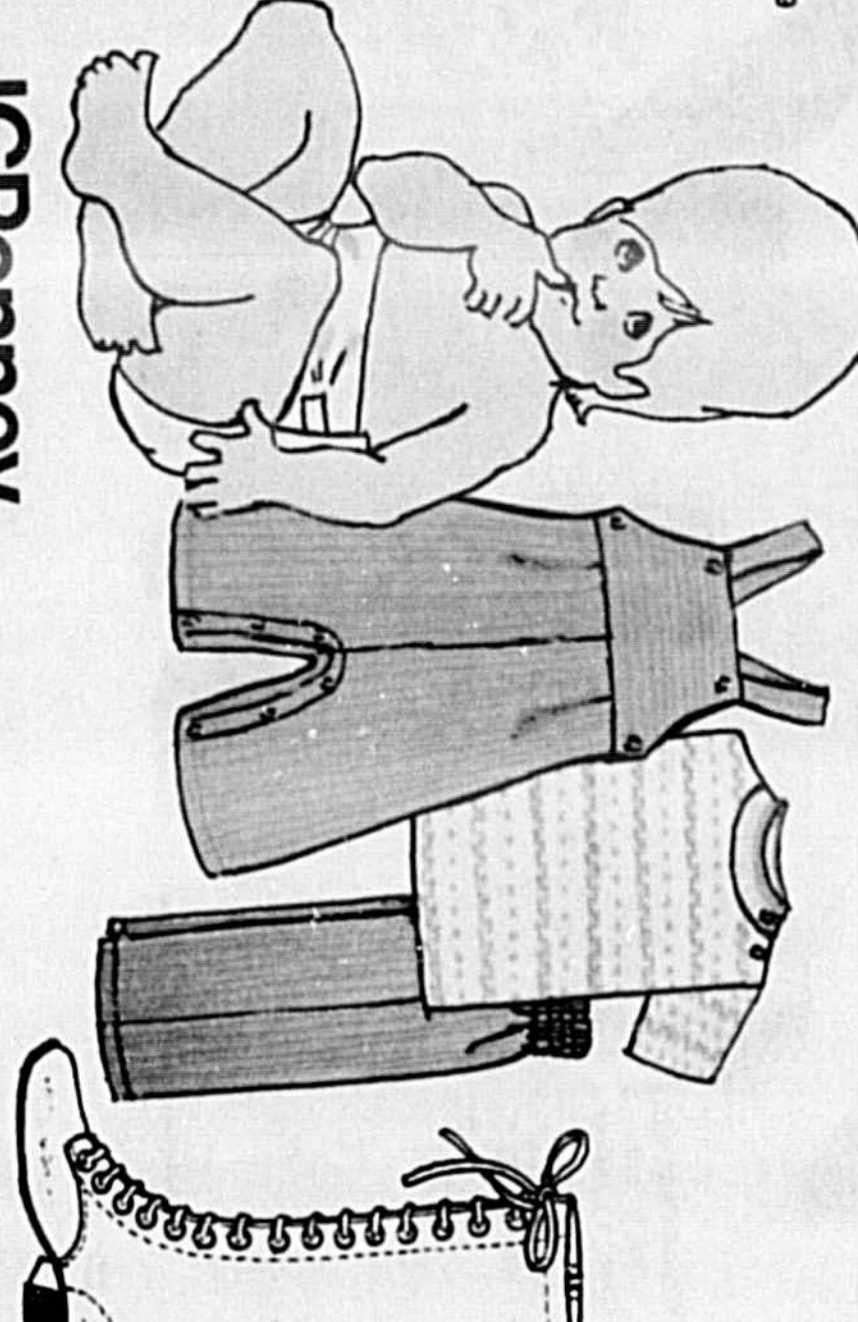

JCPenney
We know what you're looking for.

Save 15% on boys' corduroy jeans. The more boys you have, the more you'll appreciate Penney Days.



JCPenney
We know what you're looking for.

FREE BY... TRAY... SPA... TUXI... CON... SEE