



WORLD IN BRIEF

Middle East Negotiators In Washington For Talks

WASHINGTON (UPI) — Egyptian, Israeli and American negotiators are gathered in Washington to try to reach at least an appearance of renewed momentum in the stalled Palestinian autonomy talks. The negotiators were invited to Washington by President Carter to work out procedures for the negotiations, which failed to achieve agreement on the future rule of the territories occupied by Israeli forces since 1967.

Begin To Rest 5 Weeks

JERUSALEM (UPI) — Prime Minister Menachem Begin, who suffered a mild heart attack in parliament Monday, will have to spend up to three weeks in the hospital and two more weeks at home before resuming his full work load, his doctor says.

Clark: Lift Iran Sanctions

WASHINGTON (UPI) — Ramsey Clark believes the United States treated Iran wrongly under the shah and ought to apologize. He called on Congress to lift the economic sanctions imposed to retaliate for the Nov. 4 hostage seizure.

Reds Reject Troop Pullout

MOSCOW (UPI) — The Soviet Union rejected today Western calls voiced by visiting West German Chancellor Helmut Schmidt for troop withdrawals from Afghanistan, saying it is not budging from demands "outside armed interference" must end first.

Pope Raps Poor Conditions

RIO DE JANEIRO, Brazil (UPI) — Pope John Paul II said mass on Rio's famed beachfront today that 2 million people gathered at the waterfront "edge the 'subhuman' conditions of Brazil's poor threatened family unity."

Sanford Man Convicted For Sex Battery

A 54-year-old Sanford man was convicted of four counts of sexual battery of a 14-year-old girl Tuesday afternoon by a Circuit Court jury after about an hour of deliberations. Clifford Milliken Jr., 422 San Marcos Ave., faces up to life imprisonment on each of the four counts. He will be sentenced on completion of a pre-sentence investigation.

Action Reports \* Fires \* Courts \* Police Beat

Richetta, represented by the public defender's office, pleaded after formally being presented with the charge filed Thursday by the Seminole County grand jury. He is expected to be tried in August for the murder of Susan Bordas, 277 S. Wynmore Road.

3 Mile Residents Return After Safe Krypton Test

HARRISBURG, Pa. (UPI) — Virginia Phillips says her suitcases are still packed. But she was willing to come home because only a small amount of radioactive krypton vented at Three Mile Island was detected in the neighborhood countryside. "We came back, but I still have some suitcases packed and I'm ready to go again," said Mrs. Phillips, 62, who fled with her husband, Lawrence, 62, an insurance salesman, to Hagerstown, Md., during the weekend.



Ingeborg Morris hugs one of her pet goats.

Mudd Slides To Rival NBC After Losing Top CBS Slot

NEW YORK (UPI) — Television correspondent Roger Mudd apparently rather would work for NBC than play second desk to anyone but Walter Cronkite at CBS. Mudd recently lost to Dan Rather as Cronkite's successor at CBS. On Tuesday, it was announced he is leaving the network he joined almost two decades ago to sign up with the competition.



ROGER MUDD ... jumps ship

... Winter Springs

(Continued From Page 1A) would be spent on police and fire protection. Another \$25,779 would go to the public works department, just less than half of that for salaries.

Woman Given Order To Move Goats

Director Jack Schuder said this morning he feels both proposals will be approved at a later date. The roads to be included are those that have been previously maintained by the county on an emergency basis. Under the proposal, 11 roads would be accepted for regular maintenance and 28 for maintenance on an emergency basis.

Novelist C.P. Snow Dead

LONDON (UPI) — C.P. Snow, Britain's 20th-century Renaissance man who was a famed novelist, playwright, scientist and Cabinet adviser, died Tuesday at his London home. He was 74.

Funeral Notice

LYNCH, THOMAS B. — Funeral services for Thomas B. Lynch 81, of U.S. Highway 17-92, DeBary, Fla., who died Tuesday night in Sanford, will be held at 10:30 a.m. Thursday at Bristow Funeral Home with the Rev. Dan Hamera officiating. Burial in Evergreen Cemetery. Wilson Funeral Home-PA in charge.

School Board To Meet

The Seminole County School Board will meet tonight at 7:30 at the school board office, 1111 Mellonville Ave., Sanford. School Board spokesman Ralph Ray said the board will discuss a proposal for allowing presidential candidates to speak at the schools. School rules currently forbid this practice, but the board has been considering amending the rules for several months.

WEATHER

NATIONAL REPORT: Showers and thunderstorms were scattered throughout much of the Western portion of the nation early today, with precipitation recorded from California through the Rockies all the way to the Iowa-Missouri border. San Angelo, Texas, received a welcome one-third inch of rain and Goodland, Kan., received nearly a half-inch when a thunderstorm moved through the area.

HOSPITAL NOTES

SEMINOLE MEMORIAL HOSPITAL JULY 1 ADMISSIONS Sanford: Charlie K. Johnson; Ida P. Jordan; Bernice McGill; Corinne E. Ray; Helen A. Trent; Loreta Vann; Marion E. Washington; Thomas F. Weiss; Francis C. McDonald; Dalton Henrietta Thomas; Othello Lake Mary; Mary E. Sheppard; New Smyrna Beach: Henry B. Williams Jr.; Osceola: Gower and Linda Sheppard; a boy; New Smyrna Beach: DISCHARGES Sanford: Irvin B. Barlen; Bernice McGill; Eddie B. Mitchell; Vera Fisher; Anne Porter; Ruth J. Querry; Mae Venable; Lily Marie Leggett; Deland: Dorene Muir; Lake Mary: Alice A. Schmidmeitler; Winter: Theresa L. Beaulah and baby boy; Deltona: BIRTHS

Evening Herald (USPS 481-380) Wednesday, July 2, 1980—Vol. 72, No. 270. Published Daily and Sunday, except Sundays by The Sanford Herald, Inc., 200 N. French Ave., Sanford, Fla. 32771. Second Class Postage Paid at Sanford, Florida 32711.

Woman Divorcing Her Husband To Marry Potts

ATLANTA (UPI) — His mother calls it stupid, but condemned killer Jack Potts is "dated" his old girlfriend has announced she is divorcing her husband so she can marry him. Diane Nicholson's husband, who learned of his impending divorce from the news on the radio, said, "I think she's making a mistake ... all they could do is hold hands."

The fire started when maintenance workers were sweating some leaking pipe joints in the bathroom of 832 D. The soldering torch touched off a fire in the partition wall studs. It was a smoky fire which took firemen several hours to put out because of the need to remove all of the plasterboard, insulation and wood which might be smoldering, he said.

Save \$2. on Nike® training shoes. Sale 19.99. Reg. 21.79 men's or women's Nike® marathon training shoe.

Save on swim trunks. Sale 5.95. Reg. 8.50. Boxer swim short of polyester/cotton has contrasting side stripe and side seam pockets. Men's S-M-L-XL.

Save on athletic shorts. Sale 2.79. Reg. 3.99. Polyester/cotton athletic short has elasticized waist; ribbon-piping trim. One back pocket. Men's S-M-L-XL.

Save on walk shorts. Sale 6.30. Reg. 9.99. Smart solid color walking short of poly/cotton has two scoop front pockets, two back pockets. Men's 30-42.

4th OF JULY SALE

30% to 40% off men's sport shirts!

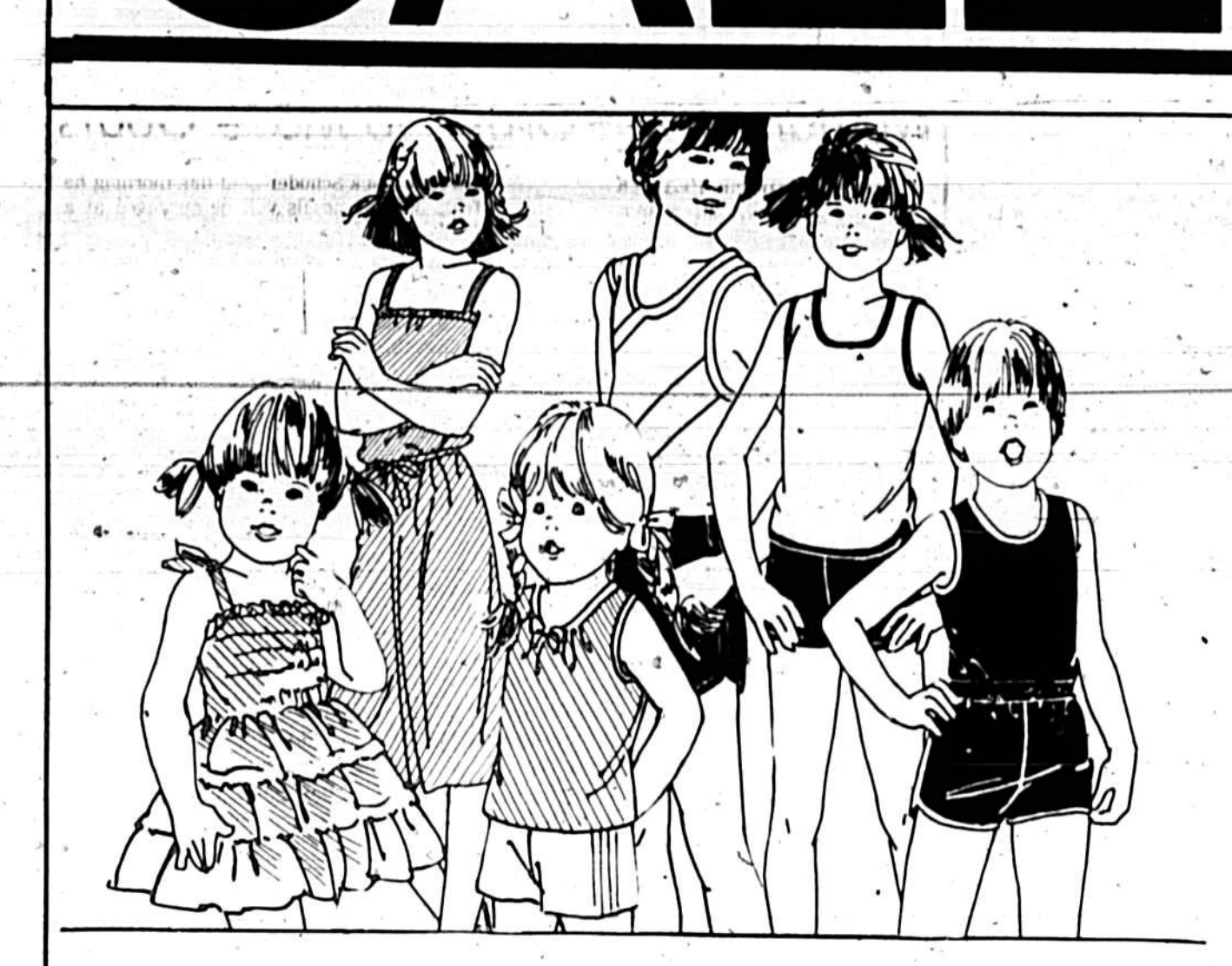

Sale 6.99. Reg. \$10. Classic knit golf shirt of cotton/poly has banded collar and yoke back for great fit. Edge stitched collar, pocket and placket. Big choice of colors. S-M-L-XL.

Table with 2 columns: Item description and Price. Items include: Kids' Summer Spectacular, Infants sundresses (3.66), Infants terry tank top or athletic shorts (1.99 each), Toddler romper boy/girl (2.22), Infant sunsuit boy/girl (1.77), Girls' tops, shorts, sundresses & tanksuits (1.66-4.99), Boys' tank tops and athletic short (1.66-3.99).

Sale 9.99. Orig. to \$15. Men's casual short sleeve shirts in checks, solids and plaids. Sizes S-M-L-XL.

Two great ways to charge: JCPenney VISA. This is JCPenney. Sanford Plaza Hwy 17-92 and State St. Open 10 a.m. to 9 p.m. Mon.-Sat. Open 12:30 to 5:30 Sunday.

SPECIAL! Tuesday & Thursday After 3 PM 1/2 CHICKEN \$1.19 DINNER. poppa jay's. where the choice is yours. 201 S. French Ave. — Ph. 322-9212 — Sanford.



# WED, THURS, FRI, SAT SALE

Shop Sanford and Orlando daily 9:30-9:30, Sun. 12-6. Shop Leesburg, Mt. Dora daily 9-9, Sun. 12-6.



Shop Kissimmee, DeLand daily 9-9, Sun. 11-6.

**ADVERTISED MERCHANDISE POLICY**  
Our firm intention is to have every advertised item in stock on our shelves. If an advertised item is not available for purchase due to any unforeseen reason, Kmart will issue a Rain Check on request for the merchandise to be purchased at the sale price whenever available or will issue a comparable quality item at a comparable reduction in price. Our policy is to give our customers "satisfaction always."



**22<sup>97</sup>** Save  
● 10 1/2" Buffet Frypan  
Pedestal legs, high vented cover, removable heat control. DuPont Approved.

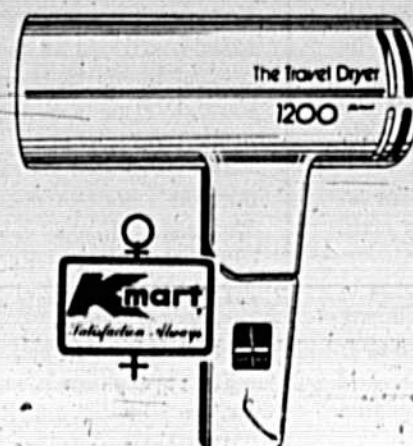

**10<sup>86</sup>** Save  
1200-W Hair Dryer  
Easy to pack, folding handle travel dryer. UL approved.



**69¢**  
Ruffles® Potato Chips  
\* For parties and snacking. 7 oz. net wt. bag. Save.



**44¢** Your Choice  
China Foam® Dinnerware  
12 snack plates, 10 plain or 10 divided platters, 12 bowls. Plastic foam.

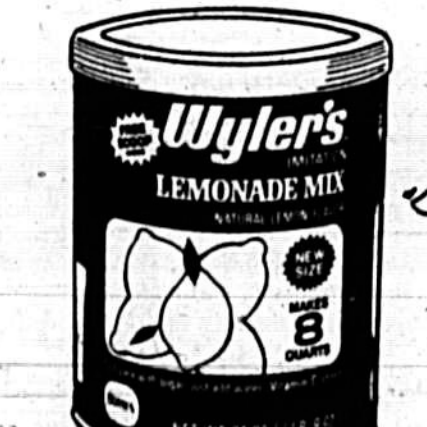

**99¢** Ea. Limit 2 Cans  
24-oz. Lemonade Mix  
Just add water. Makes 8 qts. Complete with sugar, scoop.



**68¢**  
200 Paper Napkins  
White luncheon-size napkins. 1 ply 11x13 1/2".



**2 \$1** FOR  
Colorful Place Mats  
17 1/2 x 11 1/4" plastic mats in a choice of colorful designs.

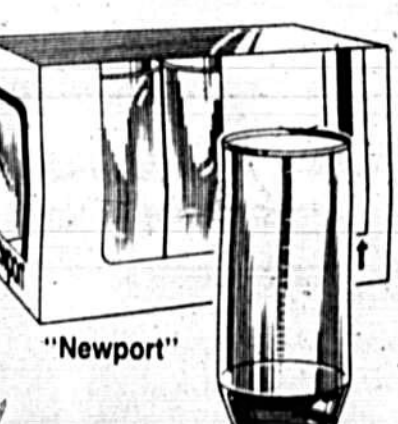

**1<sup>88</sup>**  
Six 16-oz. Tumblers  
Glass tumblers in a choice of crystal clear or gold tone.



**2<sup>88¢</sup>** FOR  
Choice of Cookies  
Coconut bars, devilfood cremes, other favorites! Save.

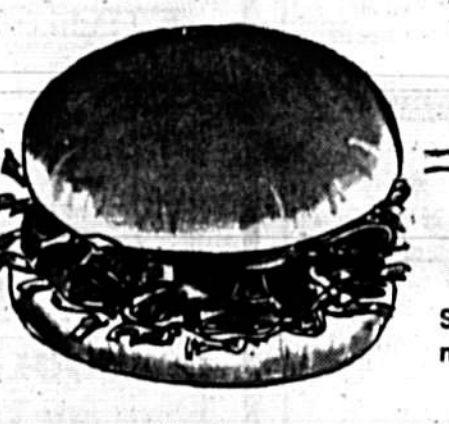

**4 \$1** Sale Price  
FOR Chopped Ham Sandwiches  
Tasty and filling. Super treat special on ham sandwiches.

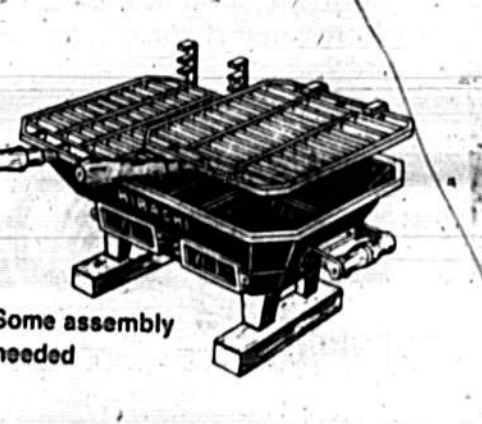

**6<sup>88</sup>**  
Table-Top Hibachi  
10 1/2 x 11 1/4" cast iron 2 adjustable grids, wooden handles.

**JULY 2-3-4-5**

**58¢** 3 Days Only  
80 Paper Picnic Plates  
Great for picnics, parties! 9" dinner-size, disposable, white paper plates at big Kmart savings.

**2<sup>97</sup>** Regent® Jarts™ Game  
Outdoor skill game for adults. 4 jarts and 2 hoops in set. Sold in Sporting Goods Dept.

**12<sup>88</sup>** Volleyball/Badminton  
4 steel rackets, volleyball, 2 shuttlecocks, 1/4" poles, net. Sold in Sporting Goods Dept.

**2<sup>97</sup>** Our Reg. 4.64  
Lantern and Battery  
1-piece floating lantern in rust-proof case. One battery. Sold in Sporting Goods Dept.

**10<sup>97</sup>** Sale!  
Oscar® 4-gallon Cooler  
Polyethylene case, built-in drink holder and lock handle. Sold in Sporting Goods Dept.

**1<sup>33</sup>** Our Reg. 1.97  
Kmart® Oil Filters  
Spin-on or cartridge type. Most U.S. and foreign cars. Sold in Auto Dept.

**2<sup>33</sup>** Ea. Your Choice  
Hard Shell® Car Waxes  
Choose from 20-oz. liquid or 14-oz.™ kit with applicator. 7% off. "Hot St." Sold in Auto Dept.

**8<sup>88</sup>** Your Choice  
Personal Size Coolers  
12-qt. double six-pack. Or 11-qt. "sun packer". Plastic.

**1<sup>73</sup>**  
1/2-Gal. Picnic Jug  
Wide mouth, hinged spout. Polyethylene, insulated.

**9<sup>96</sup>** 3 Days Only  
35-qt. Thermos® Chest  
Polystyrene with polyurethane insulation. Hinged lid.

Copyright 1980 by K Mart Corporation

- MT. DORA: 17 GOLDEN TRIANGLE SHOPPING CENTER
- WEST ORLANDO: 2185 WEST COLONIAL NEAR TEXAS AVE.
- KISSIMMEE: U.S. HWY. 192, VINE ST. AT THACKER AVE.
- S.E. ORLANDO: 2811 SOUTH SEAMOR AT CURRY FORD
- LEESBURG: NORTH CITRUS BLVD. AT U.S. HWY. 41 & 37
- EAST COLONIAL: HERNDON PLAZA ACROSS FROM FASHION SQUARE
- SANFORD: U.S. HWY. 17-92 AT AIRPORT BLVD.
- S. ORLANDO: 2923 S. ORANGE BLVD. TRAIL AT SAND LAKE RD.
- DELAND: 1201 SOUTH WOODLAND BLVD.
- CASSELBERRY: U.S. HWY. 17-92 NEXT TO JAI-ALAI FRONTON
- PINE HILLS: HIAWASSEE RD. AT SILVER STAR RD.
- ALTAMONTE SPRINGS: 181 W. HWY. 408 AT FOREST CITY RD.

# Shop Sanford and Orlando daily 9:30-9:30, Sun. 12-6. SPARKLING SAVINGS

Shop Kissimmee and DeLand daily 9-9, Sun. 11-6.

# USA HOLIDAY SALE

**2<sup>58</sup>** Boys' Colorful Polos  
Conversation prints on solid tone grounds. Polyester cotton.

**2<sup>24</sup>** Jr. Boys' Polos  
Fun prints on solid color backgrounds. Polyester cotton. 4-7.

**2<sup>94</sup>** Men's Conversation Polos  
Colorful prints on solid color grounds. Polyester cotton.

**3** Misses' Polyester Shorts.  
Choose from a terrific assortment of solid colors, Jamaicas. Shop and Save now at Kmart.

**1<sup>37</sup>** Each 3 Days Only  
Color Print Film Sale  
110/20 or 120/20 or 135/20. Any 3 rolls, mix or match.

**12<sup>88</sup>** 3 Days Only  
126 Instamatic® Camera  
X15 camera, 126 color print film, monograms, wrist strap.

**2<sup>77</sup>** 9-18 Mos., 2-4  
Infants, Tots' PJ's  
Short sleeved print top, solid color bottom. Cordelan® kojhin.

**10<sup>97</sup>** For runners, coaches, athletes  
Wristwatch/Stopwatch  
LCD readout. Shows hours, minutes, seconds, month, date.

**1<sup>22</sup>** 3 Days Only  
18-oz. Listerine  
Antiseptic mouthwash has pleasant, fresh taste. Save.

**74¢** Pair  
Choice of Misses' Socks  
Terry lined stretch cotton, 10-11 1/2 Cotton / stretch nylon, 9-11.

**12<sup>97</sup> 5<sup>97</sup>** Chair  
Lawn Chaise Or Chair  
Folding garden furniture of plastic webbing on a weather-resistant aluminum frame.

**2<sup>94</sup>** Our Reg. 3.96  
Classic Terry Tee's  
Polyester tee shirts with versatile neck line in smashing colors! Misses' sizes. Save at Kmart.

**84<sup>97</sup>** 20" Rotary Power Mower  
20" side discharge, 3 HP recoil start engine, 3/4" loop handle with throttle control on handle. Save.

**11** 100' Extension Cord  
Indoor / outdoor. 3-wire grounded. Save at Kmart.

**94¢** Roll Special Purchase  
2" X 15-yd. Duct Tape  
Self-adhering, polyethylene coated. Withstands heat, cold.

**1<sup>94</sup>** Ea.  
8x24" Sturdy Shelving  
Walnut-look particleboard makes attractive shelving.

**4<sup>97</sup>** 12" Jumbo Thermometer  
Both celsius and fahrenheit readings. Large figures. Save.

**2<sup>28</sup>** 3 Days Only  
50' Garden Hose/Reel  
3/4" inside dia. Non-toxic. Winds into 13.5" x 13" case. Save.

**2<sup>22</sup>** Your choice  
Coppertone or Hawaiian Tropic protect you from the sun. 4-oz.

**2<sup>77</sup>** Solarcaine Spray  
5 oz. aerosol can relieves sunburn pain, quick!

**4<sup>57</sup>** 5-qt.  
Latex Flat Wall Paint  
"Big Bucket" one-coat fast drying latex. White, colors.

# WED., THURS., FRI., SAT. SALE





Evert Shows Jaeger Killer Instinct

Borg Scraps Wimbledon History Books

WIMBLEDON (UPI) — It wasn't a match to live long in memory, but it was good enough to earn Bjorn Borg a unique place in Wimbledon tennis history.

When I started to play, Laver was my idol when I was 9 years old. "Until I was 15, everybody was talking about Laver. To beat this kind of record, especially when Laver is involved, means so much to me."

Paul got things going for the Sanford Nationals in the top of the first inning with a grand slam home run. Dexter Franklin had reached base on an error with one out, Grayson was intentionally walked and Theodore Graham drew a two-out walk before Paul's blast to left field.

Little Nationals-Americans Meet

Sub-District All Sanford Final

The Sanford National League all-stars defeated Paola 10-2 Tuesday night to set the stage for an all-Sanford title game in the Florida Little Major League sub-district tournament.

Paul got things going for the Sanford Nationals in the top of the first inning with a grand slam home run. Dexter Franklin had reached base on an error with one out, Grayson was intentionally walked and Theodore Graham drew a two-out walk before Paul's blast to left field.

While Grayson is almost certain to start for the Sanford Nationals tonight, the Sanford Americans can go with any one of several pitchers including Brian Ashcraft, Brian Sheffield, Reginald Hayes and Eddie Korgan.

Relief pitcher Antoine Cockheran belted a leadoff home run in the fourth inning for the first Paola run, but the Nationals put the game out of reach with five runs in the top of the fifth.

To have a chance in the tournament, the Sanford Nationals had to win without pitching Grayson Tuesday night. Manager W. J. Ward Sr. gave the nod to Dewaine Mitchell, and Mitchell went the distance, scattering seven hits and striking out eight. Mitchell's teammates provide almost flawless play, committing only one error and turning in some fielding gems.

Paul, Armstrong and Graham each belted a pair of hits for the Sanford Nationals, while Troy Turner and Cockheran each hit safely twice for Paola.

Table with columns: Player, AB, R, H, E. Lists players like Dexter Franklin, Grayson, Paul, etc.

Table with columns: Player, AB, R, H, E. Lists players like Dexter Franklin, Grayson, Paul, etc.

American League Roundup

Steady Eddy Keeps Yanks Streaking

By United Press International. Ed Figueroa may soon be referring to opposing batters as the "friendly confines."

Ed Figueroa may soon be referring to opposing batters as the "friendly confines." Just the game, he said, the mood of Figueroa Tuesday night after allowing two runs over 5 1/3 innings as the New York Yankees posted a \$2 triumph over the Boston Red Sox.

National League Roundup

Pirates Shade Struggling Cards 3-2 In 10th

By United Press International. Although his team had lost its second one-run game to the Pittsburgh Pirates in as many nights, Walley Hergert thought the time was right to praise his St. Louis Cardinals.

Although his team had lost its second one-run game to the Pittsburgh Pirates in as many nights, Walley Hergert thought the time was right to praise his St. Louis Cardinals.

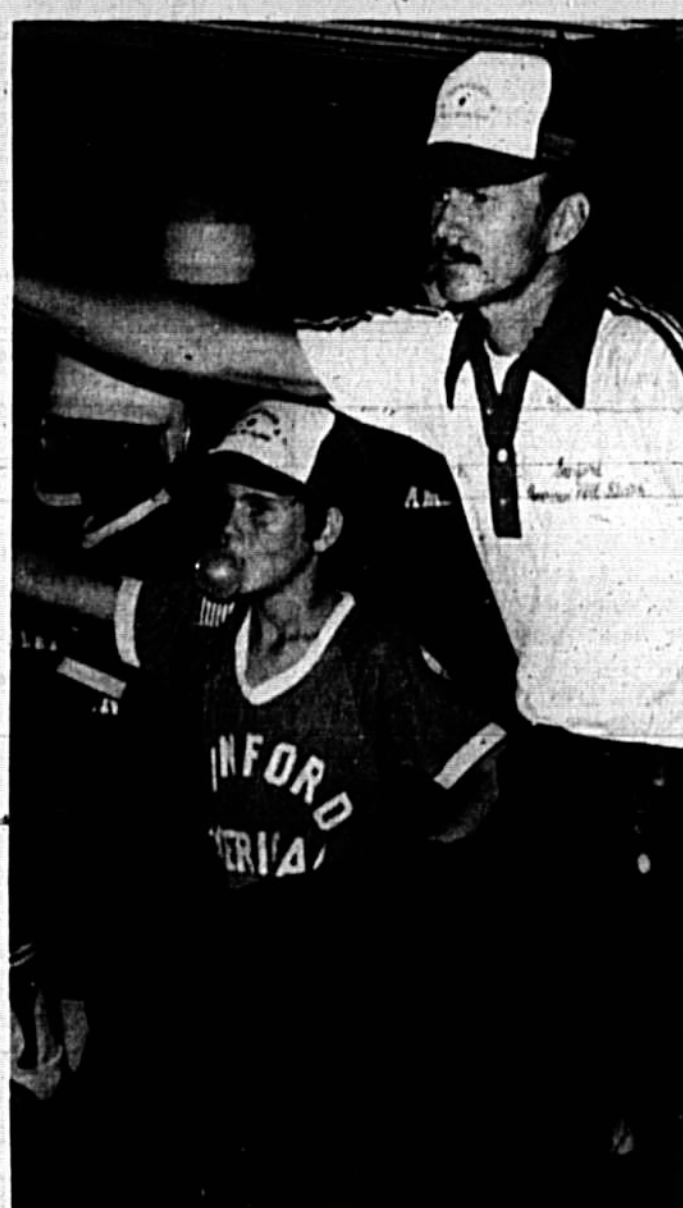

Herald Photo by Tom Vincent. The long and short of it, two figures very much interested in the Little National victory Tuesday night were Little American manager Doug Atkinson and bat boy Mike Holcomb.

Sore-Armed Ewert Facing Retirement

CINCINNATI (UPI) — The Cincinnati Reds announced Tuesday Tom Seaver, whose painful pitching arm has hurt his performance, is returning immediately from a San Francisco road trip to Cincinnati for a medical examination.

K.C.'s Brett Overt Of All-Star Tilt

KANSAS CITY (UPI) — George Brett, the starting All-Star third baseman for the American League, will not play in the July 8 All-Star Game in Los Angeles, the Kansas City Royals announced Tuesday.

Brett was examined Tuesday by Dr. William Benson and was given approval to begin taking batting practice. Brett tore ligaments in his right ankle three weeks ago and has been on the disabled list since June 10.

Rivals Smash World Mark At Oslo Meet

OSLO, Norway (UPI) — Move over Sebastian Coe — here comes Steve Ovett. Ovett set a world record for the mile Tuesday with a time of 3 minutes, 48.8 seconds — two tenths of a second faster than Coe's mark set last summer on the same Biallet International track.

Baseball Card Competitor Bursts Topps Big Bubble

PHILADELPHIA (UPI) — A judge has ended Topps Cheewing Gum's monopoly of the bubble gum baseball card market and ordered the company to pay triple damages of \$1 to a competitor.

SCOREBOARD

Baseball

Table with columns: Team, W, L, Pct, GB. Lists MLB teams and their records.

Table with columns: Team, W, L, Pct, GB. Lists minor league teams and their records.

Table with columns: Team, W, L, Pct, GB. Lists minor league teams and their records.

Table with columns: Team, W, L, Pct, GB. Lists minor league teams and their records.

Table with columns: Team, W, L, Pct, GB. Lists minor league teams and their records.

Table with columns: Team, W, L, Pct, GB. Lists minor league teams and their records.

Table with columns: Team, W, L, Pct, GB. Lists minor league teams and their records.

Table with columns: Team, W, L, Pct, GB. Lists minor league teams and their records.

Table with columns: Team, W, L, Pct, GB. Lists minor league teams and their records.

Table with columns: Team, W, L, Pct, GB. Lists minor league teams and their records.

Table with columns: Team, W, L, Pct, GB. Lists minor league teams and their records.

Table with columns: Team, W, L, Pct, GB. Lists minor league teams and their records.

Table with columns: Team, W, L, Pct, GB. Lists minor league teams and their records.

Table with columns: Team, W, L, Pct, GB. Lists minor league teams and their records.

Table with columns: Team, W, L, Pct, GB. Lists minor league teams and their records.

Table with columns: Team, W, L, Pct, GB. Lists minor league teams and their records.

Table with columns: Team, W, L, Pct, GB. Lists minor league teams and their records.

Table with columns: Team, W, L, Pct, GB. Lists minor league teams and their records.

Table with columns: Team, W, L, Pct, GB. Lists minor league teams and their records.

Table with columns: Team, W, L, Pct, GB. Lists minor league teams and their records.

4th OF JULY SALE

Advertisement for Igloo coolers. Features images of coolers and text: "Save on our entire stock of Igloo coolers! Sale 19.99, Sale 9.99, Sale 13.99, Sale 24.99, Sale 29.99, Sale 23 to 29, Save \$32 to \$56, Rustproofing service, Mileagemaker premium 15-step tune up, Sale 11.88." Includes a "Save 25%" offer on Leach shirts.

Advertisement for Mileagemaker tires. Features images of tires and text: "Save \$23 to \$29 on 4 poly tires. The Mileagemaker passenger tire features a full 4 ply body. Blackwall. Whitewall extra preferred." Includes a table of tire prices.

Advertisement for JCPenney batteries. Features images of batteries and text: "Give a darn... Sale \$54. With trade-in, Reg. \$65. Dependable JCPenney 5-Year Battery never needs water. Group sizes for American and imported cars." Includes a "FIRST TIME EVER ON SALE!" banner.









DEAR DR. LAMB - About a year ago I went on the Scarsdale diet and went from 120 pounds to 110. Since then I've kept my weight steady around 110 pounds. Within the last two months I've begun to lose even more and I'm now at 100 pounds. My body has lost all of its elasticity, especially in my arms and breasts. Is there anything I can do to improve my body's firmness and elasticity?

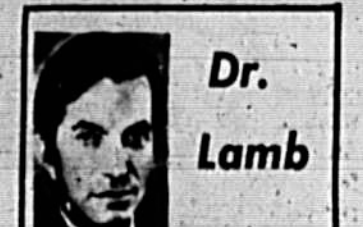

You might also want to know that even if you diet enough protein in your diet if you don't have enough calories that protein will be used for energy. That means the protein is not available to rebuild the normal wear and tear of body structures or to grow new muscles.

People who are on a sensible diet because they really do have a problem with being overweight can do a lot to prevent loss of muscle and sagging skin by using an exercise program while they're dieting. If your diet is too restricted and particularly if you're not exercising, you will lose muscle tissue. The classic examples are the prisoners of war in concentration camps that came back with emaciated bodies.

Being overweight is a serious health problem. Undernutrition is another serious health problem most often occurring in women on fat diets. A lot of people who go on fat diets are literally on starvation or semi-starvation diets that are really health wreckers.

HOROSCOPE

YOUR BIRTHDAY July 2, 1980 Friends you meet this coming year who are from a foreign land or who live in a distant place could prove lucky for you. Take advantage of all opportunities to make this type of contact.

LEO (July 23-Aug. 22) - Business or commercial matters could be far more complicated than usual today. Be extremely careful in your dealings whether they are large or small.

LIBRA (Sept. 23-Oct. 23) - Be selective regarding the tasks that confront you today. Tackle only those you feel persistent enough to finish.

TAURUS (April 20-May 19) - You can't be all things to all people today, so your best course of action is to think own self be true. Pretenses will work against you.

SCORPIO (Oct. 24-Nov. 22) - Be able to distinguish between sensible risks and outlandish gambles. Losses could occur if you are foolish with your resources.

Pick Of The Season

Cheese Perfect With Fruit And Vegetables

Summer truly means the "pick of the season" - a time when menus reflect the seasonal abundance of some of America's favorite foods. Fresh vegetables and fruits become featured items at mealtime, either served fresh and crisp or in recipes in combination with other ingredients.

love this fruity, rich-flavored Blueberries 'N Cheese Coffee Cake, made with cubes of cream cheese in the batter. The combination of summer's best fresh vegetables and fruits with your "cheese-fest" promises a season of delicious eating ahead.

BLUEBERRIES 'N CHEESE COFFEE CAKE 1 1/2 cups sugar 2 cups margarine 2 eggs 2 1/2 cups flour 1 1/2 teaspoons baking powder 1 teaspoon salt 1/2 cup milk 1 1/2 cups water 2 cups blueberries 1 8-oz. pkg. Philadelphia Brand cream cheese, cubed 1 teaspoon grated lemon rind

STAINED GLASS FRUIT SQUARES 2 1/2 cups margarine 1/2 cup sugar 1/2 teaspoon vanilla 1 1/2 cups flour 2 3-oz. jars Kraft neuchatel cheese spread with pineapple Assorted fruits

Valuable Coupon Picnic Mayonnaise 32 oz. jar 28¢ Limit 1 with \$25.00 order excluding cigarettes & coupon items. Coupon Expires Sat., July 5, 1980.

Valuable Coupon Blue Ribbon Toilet Tissue 4 Rolls 28¢ Limit 1 with \$25.00 order excluding cigarettes & coupon items. Coupon Expires Sat., July 5, 1980.

Valuable Coupon Tide Detergent 49 oz. box 99¢ Limit 1 with \$25.00 order excluding cigarettes & coupon items. Coupon Expires Sat., July 5, 1980.

Valuable Coupon Totino's Party Pizza 12 1/2 oz. saus., cheese, pepperoni 78¢ Limit 1 with \$15.00 order excluding cigarettes and coupon items. Coupon Expires Sat., July 5, 1980.

FOOD BARN advertisement featuring various meat products like Salisbury Steak Patties, Beef Patties, Pork Sausage Patties, Sirloin Steaks, and more, along with coupons and prices.

USE YOUR VISA OR MASTER CHARGE ON ALL ITEMS LISTED TO THE RIGHT Bryan All Meat Salami 5 Lb. Box \$4.98 Carolina Pride All Meat Wieners 7 Lb. Box \$4.88 Skinned, Devilled, Sliced Beef Liver 5 Lb. Box \$2.98





